



PROTECT BEL

Sicherheitsleuchte mit Schutzart IP65 aus Polycarbonat mit klarer Leuchtenhaube zur Flächenausleuchtung.

Für die ungeschützte Außenmontage bieten wir ein Zubehörset mit Druckausgleichsventil an. In den Versionen mit Akkuheizung und externer Versorgung ist das Druckausgleichsventil immer in der Leuchte integriert.

Die Leuchte ist optional als Set mit Versorgungseinheit zur Montage im Innenbereich und Leuchteneinheit zur Installation im Außenbereich lieferbar.

Alternativ ist die Leuchte mit Heizungscontainer inkl. Akku 4,8V 4,2Ah für LED 3W und 6W (3h)/1,5W und 6W (8h) zur Erweiterung des Temperaturbereiches bis -20°C erhältlich.

Optional kann die Leuchte als Zentralbatterie-Variante für einen Temperaturbereich bis -35°C geliefert werden (unüberwacht).



Technische Daten

Anschlussklemmen	2 x 2,5 mm ² für Doppelbelegung
Gehäuse/Farbe	Polycarbonat / weiß (Leuchtenhaube klar)
Montageart	Decken- und Wandmontage
Abmessungen (B x H x T)	370 x 140 x 93 mm (Leuchte)
	254 x 90 x 180 mm (optionale Versorgungseinheit) max. 20m Verbindungskabel zwischen Leuchte und Versorgungseinheit. Anzahl der Adern: min. 4 x 1,5mm ²
Schutzart	IP65
Schutzklasse	II

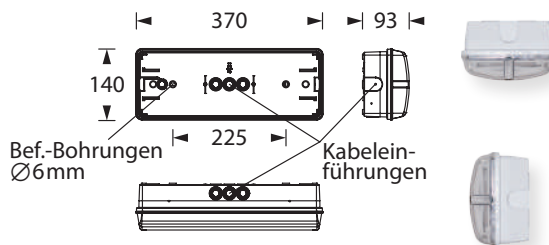

WWW.ELEKTROPLANET.CH
INFO@ELEKTROPLANET.CH

+41 44 950 10 10
+41 44 950 10 44

Leuchtmittel	■ Systemleuchten für Zentralversorgung				■ Einzelbatterie-leuchten		
	1,5W LED-Leiste	3W LED-Leiste	6W LED-Leiste	10W LED-Leiste	1,5W LED-Leiste	3W LED-Leiste	6W LED-Leiste
Lichtstrom	190lm	350lm	600lm	1.050lm	190lm (Netz)	350lm (Netz)	580lm (Netz)
Nennbetriebsdauer 1h/3h	-	-	-	-	190lm (Not)	350lm (Not)	580lm (Not)
Nennbetriebsdauer 8h	-	-	-	-	190lm (Not)	-	320lm (Not)
Lichtstromverhältnis							
Not (DC)/Netz 1h/3h	-	-	-	-	100% / 100%	100% / 100%	100% / 100%
Not (DC)/Netz 8h	-	-	-	-	100% / 100%	-	55% / 100%
Netzanschlussleistung	5VA	6VA	10,3VA	15VA	5VA	6VA	11,5VA
Batterie-Stromaufnahme	12mA	19mA	27mA	41mA	-	-	-
Anschlussspannung	230V 50/60Hz / 220V DC +25/-20%				230V 50/60Hz NiMh-Akku		
NiMh-Akku 1h	-	-	-	-	4,8V 2,0Ah	4,8V 2,0Ah	4,8V 2,0Ah
NiMh-Akku 3h	-	-	-	-	4,8V 2,0Ah	4,8V 4,2Ah	4,8V 4,2Ah
NiMh-Akku 8h	-	-	-	-	4,8V 4,2Ah	-	4,8V 4,2Ah
Temperaturbereich	-10°C bis +40°C				-		
Bereitschaftsschaltung	-	-	-	-	-0°C bis +35°C ¹⁾ -5°C bis +30°C ¹⁾		
Dauerschaltung	-	-	-	-	-		
optional:							
Leuchtschalt- und Überwachungsbaustein	ELC MSÜ3 SET009 SET010	ELC MSÜ3 SET009 SET010 DALI	ELC MSÜ3 SET009 SET010	ELC MSÜ3 SET009 SET010	-	-	-
Selbstüberwachung	-	-	-	-	SELF CHECK		
Busüberwachung	-	-	-	-	SAFELOG Line SAFELOG Wireless		

¹⁾Optional lieferbar mit eingebautem Heizungscontainer inkl. Akku (4,8V 4,2Ah) für LED 3W und 6W (3h)/1,5W und 6W (8h) für Temperatureinsatzbereich bis -20°C.

Technische Änderungen vorbehalten/Technical changes reserved

INDUSTRIESTRASSE 2
CH-8335 HITTLAU



Zubehör

- Ballwurfschutzkorb _____
- Zentralpendel _____
- Seilmontageset _____
- Druckausgleichsventil Zubehörset für ungeschützte Montage _____

Optional



Versorgungseinheit



Heizungscontainer

Lichtverteilungskurven und Leuchtenabstandstabellen (E = 1,25 lx)

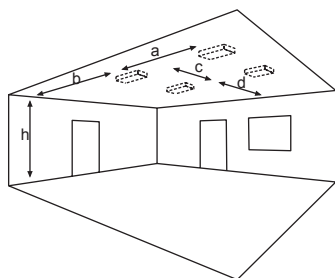

Deckenmontage

■ Systemleuchten für Zentralversorgung

Abstandstabelle ebene Fluchtwege / Tabellenangaben in Meter

Leuchtmittel: 1,5W LED-Leiste

Lampenlichtstrom Not (DC)/Netz: 190lm / 190lm

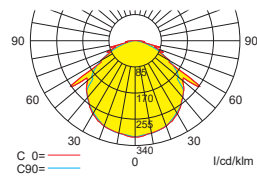

h	2,50	3,00	3,50	4,00	4,50	5,00	5,50	6,00	6,50	7,00	7,50	8,00
a	7,90	8,50	8,90	9,00	9,30	9,60	9,50	9,40	9,10	8,70	7,50	6,20
b	3,15	3,20	3,40	3,30	3,30	3,10	2,80	2,50	2,00	1,30	0,50	0,40
c	7,70	9,00	9,50	9,50	9,60	9,70	9,60	9,40	9,10	8,70	7,50	6,20
d	3,60	3,40	3,40	3,30	3,30	3,20	2,90	2,50	2,00	1,50	0,50	0,50

Leuchtmittel: 3W LED-Leiste

Lampenlichtstrom Not (DC)/Netz: 350lm / 350lm

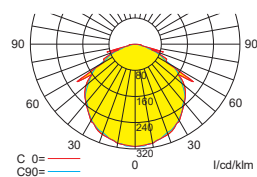

h	2,50	3,00	3,50	4,00	4,50	5,00	5,50	6,00	6,50	7,00	7,50	8,00	8,50	9,00	9,50	10,00
a	9,20	10,20	11,00	11,50	11,90	12,20	12,50	12,70	12,80	12,80	12,70	12,40	12,20	11,90	11,50	10,50
b	3,90	4,10	4,30	4,50	4,60	4,60	4,50	4,40	4,30	4,10	3,80	3,40	2,90	2,30	1,80	1,00
c	9,20	10,20	11,50	11,90	12,70	12,40	12,80	12,90	13,00	12,90	12,80	12,60	12,30	12,00	11,60	10,80
d	4,10	4,70	4,40	4,60	4,60	4,60	4,60	4,40	4,30	4,10	3,80	3,50	3,00	2,60	1,90	1,00

Leuchtmittel: 6W LED-Leiste

Lampenlichtstrom Not (DC)/Netz: 600lm / 600lm

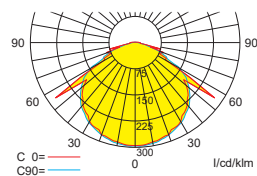

h	2,00	3,00	4,00	5,00	6,00	7,00	8,00	9,00	10,00	11,00	12,00
a	9,60	11,80	14,00	15,30	16,30	16,90	17,10	17,20	17,00	16,40	15,60
b	4,00	5,00	5,60	5,90	6,00	5,90	5,70	5,20	4,40	3,20	2,20
c	9,70	11,50	13,30	15,60	16,60	16,60	16,80	16,80	16,70	16,10	15,10
d	3,80	4,80	6,00	5,80	5,90	5,90	5,60	5,10	4,20	3,00	2,80

Leuchtmittel: 10W LED-Leiste

Lampenlichtstrom Not (DC)/Netz: 1.050lm / 1.050lm

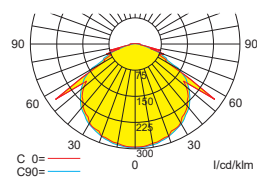

h	2,00	3,00	4,00	5,00	6,00	7,00	8,00	9,00	10,00	11,00	12,00	13,00	14,00	15,00
a	10,10	13,60	15,30	17,60	19,20	20,40	21,10	21,70	21,90	22,10	21,90	21,70	21,00	20,30
b	4,30	5,50	6,60	7,20	7,50	7,70	7,80	7,70	7,40	7,00	6,30	5,50	4,20	2,00
c	10,40	12,80	15,10	16,80	19,10	20,80	21,80	21,20	21,50	21,70	21,40	21,30	20,70	19,80
d	4,00	5,30	6,50	7,60	7,30	7,60	7,60	7,50	7,30	6,80	6,30	5,20	4,00	1,70

Fortsetzung nächste Seite



Einzelbatterieleuchten

Abstandstabelle ebene Fluchtwege / Tabellenangaben in Meter

Leuchtmittel: 1,5W LED-Leiste

Lampenlichtstrom Not/Netz: 190lm/190lm – Nennbetriebsdauer: 1h/3h/8h

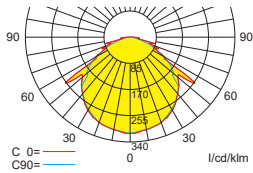

h	2,50	3,00	3,50	4,00	4,50	5,00	5,50	6,00	6,50	7,00	7,50	8,00
a	7,90	8,50	8,90	9,00	9,30	9,60	9,50	9,40	9,10	8,70	7,50	6,20
b	3,15	3,20	3,40	3,30	3,30	3,10	2,80	2,50	2,00	1,30	0,50	0,40
c	7,70	9,00	9,50	9,50	9,60	9,70	9,60	9,40	9,10	8,70	7,50	6,20
d	3,60	3,40	3,40	3,30	3,30	3,20	2,90	2,50	2,00	1,50	0,50	0,50

Leuchtmittel: 3W LED-Leiste

Lampenlichtstrom Not/Netz: 350lm/350lm – Nennbetriebsdauer: 1h/3h

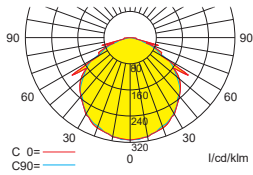

h	2,50	3,00	3,50	4,00	4,50	5,00	5,50	6,00	6,50	7,00	7,50	8,00	8,50	9,00	9,50	10,00
a	9,20	10,20	11,00	11,50	11,90	12,20	12,50	12,70	12,80	12,80	12,70	12,40	12,20	11,90	11,50	10,50
b	3,90	4,10	4,30	4,50	4,60	4,60	4,50	4,40	4,30	4,10	3,80	3,40	2,90	2,30	1,80	1,00
c	9,20	10,20	11,50	11,90	12,70	12,40	12,80	12,90	13,00	12,90	12,80	12,60	12,30	12,00	11,60	10,80
d	4,10	4,70	4,40	4,60	4,60	4,60	4,60	4,40	4,30	4,10	3,80	3,50	3,00	2,60	1,90	1,00

Leuchtmittel: 6W LED-Leiste

Lampenlichtstrom Not/Netz: 580lm/580lm – Nennbetriebsdauer: 1h/3h

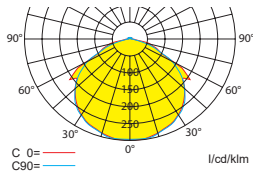

h	2,00	3,00	4,00	5,00	6,00	7,00	8,00	9,00	10,00	11,00
a	9,89	12,21	14,05	15,22	16,13	16,71	16,96	17,04	16,90	16,38
b	4,17	5,08	5,60	5,91	6,01	5,98	5,71	5,17	4,38	3,05
c	10,08	12,07	14,42	16,13	16,78	16,67	17,00	16,97	16,74	16,21
d	4,13	5,29	5,96	5,90	6,01	5,93	5,65	5,14	4,32	2,98

Leuchtmittel: 6W LED-Leiste

Lampenlichtstrom Not/Netz: 320lm/580lm – Nennbetriebsdauer: 8h

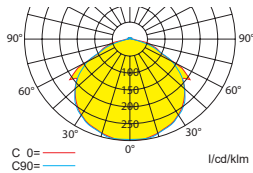

h	2,00	3,00	4,00	5,00	6,00	7,00	8,00
a	8,51	10,48	11,6	12,31	12,61	12,64	12,27
b	3,61	4,17	4,43	4,46	4,22	3,64	2,50
c	8,45	10,77	12,31	12,30	12,63	12,55	12,14
d	3,66	4,44	4,44	4,43	4,17	3,61	2,48

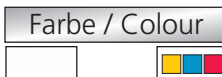

PROTECT BEL-R

Sicherheitsleuchte mit Schutzart IP65 aus Polycarbonat mit klarer Leuchtenhaube und Rast-Optiken zur Fluchtwegausleuchtung für Deckenmontage.

Für die ungeschützte Außenmontage bieten wir ein Zubehörset mit Druckausgleichsventil an. In den Versionen mit Akkuheizung und externer Versorgung ist das Druckausgleichsventil immer in der Leuchte integriert.

Die Leuchte ist optional als Set mit Versorgungseinheit zur Montage im Innenbereich und Leuchteneinheit zur Installation im Außenbereich lieferbar.

Alternativ ist die Leuchte mit Heizungscontainer inkl. Akku 4,8V 4,2Ah für LED 3W und 6W (3h) / 6W (8h) zur Erweiterung des Temperaturbereiches bis -20°C erhältlich.

Optional kann die Leuchte als Zentralbatterie-Variante für einen Temperaturbereich bis -35°C geliefert werden (unüberwacht).

Technische Daten

Anschlussklemmen	2 x 2,5 mm ² für Doppelbelegung
Gehäuse/Farbe	Polycarbonat / weiß (Leuchtenhaube klar)
Montageart	Deckenmontage
Abmessungen (B x H x T)	370 x 140 x 93 mm (Leuchte) 254 x 90 x 180 mm (optionale Versorgungseinheit) max. 20 m Verbindungskabel zwischen Leuchte und Versorgungseinheit. Anzahl der Adern: min. 4 x 1,5 mm ²
Schutzart	IP65
Schutzklasse	II

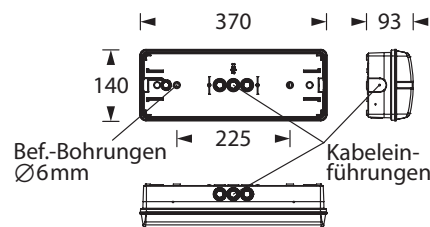

Leuchtmittel	■ Systemleuchten für Zentralversorgung			■ Einzelbatterie-leuchten	
	3W LED-Leiste	6W LED-Leiste	10W LED-Leiste	3W LED-Leiste	6W LED-Leiste
Lichtstrom	350lm	600lm	1.050lm	350lm (Netz)	580lm (Netz)
Nennbetriebsdauer 1h/3h	-	-	-	350lm (Not)	580lm (Not)
Nennbetriebsdauer 8h	-	-	-	-	320lm (Not)
Lichtstromverhältnis					
Not (DC)/Netz 1h/3h	-	-	-	100%/100%	100%/100%
Not (DC)/Netz 8h	-	-	-	-	55%/100%
Netzanschlussleistung	6VA	10,3VA	15VA	6VA	11,5VA
Batterie-Stromaufnahme	19mA	27mA	41mA	-	-
Anschlussspannung	230V 50/60Hz / 220V DC +25/-20%			230V 50/60Hz NiMh-Akku	
NiMh-Akku 1h	-	-	-	4,8V 2,0Ah	4,8V 2,0Ah
NiMh-Akku 3h	-	-	-	4,8V 4,2Ah	4,8V 4,2Ah
NiMh-Akku 8h	-	-	-	-	4,8V 4,2Ah
Temperaturbereich	-10°C bis +40°C			-	-
Bereitschaftsschaltung	-	-	-	-0°C bis +35°C ¹⁾	-
Dauerschaltung	-	-	-	-5°C bis +30°C ¹⁾	-
optional:					
Leuchtschalt- und Überwachungsbaustein	ELC MSÜ3 SET009 SET010 DALI	ELC MSÜ3 SET009 SET010	ELC MSÜ3 SET009 SET010	-	-
Selbstüberwachung	-	-	-	SELF CHECK	
Busüberwachung	-	-	-	SAFELOG Line SAFELOG Wireless	

¹⁾Optional lieferbar mit eingebautem Heizungscontainer inkl. Akku (4,8V 4,2Ah) für LED 3W und 6W (3h)/6W (8h) für Temperatureinsatzbereich bis -20°C.

Zubehör

- Ballwurfschutzkorb
- Zentralpendel
- Seilmontageset
- Druckausgleichsventil Zubehörset für ungeschützte Montage

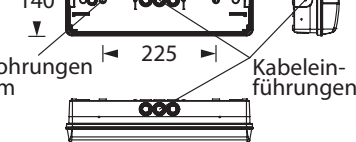

optional: Versorgungseinheit



optional: Heizungscontainer

Lichtverteilungskurven und Leuchtenabstandstabellen (E = 1,25 lx)

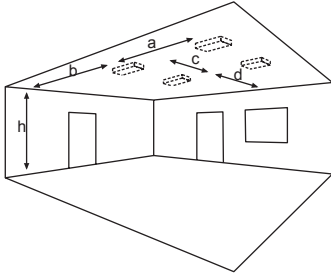

Deckenmontage

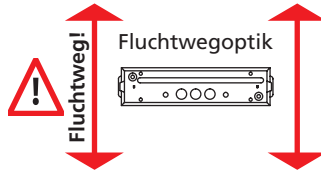

Einbaueinrichtung

Systemleuchten für Zentralversorgung

Abstandstabelle ebene Fluchtwege / Tabellenangaben in Meter

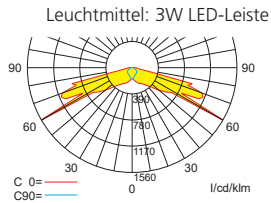

Lampenlichtstrom Not (DC)/Netz: 350lm / 350lm

h	2,50	3,00	3,50	4,00	4,50	5,00	5,50	6,00
a	-	-	-	-	-	-	-	-
b	-	-	-	-	-	-	-	-
c	18,50	19,60	20,30	21,90	23,40	23,50	24,70	24,60
d	7,50	8,20	9,10	9,40	9,60	9,40	7,80	6,90

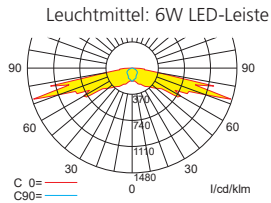

Lampenlichtstrom Not (DC)/Netz: 600lm / 600lm

h	2,50	3,00	3,50	4,00	4,50	5,00	5,50	6,00	6,50	7,00	7,50	8,00	8,50	9,00
a	-	-	-	-	-	-	-	-	-	-	-	-	-	-
b	-	-	-	-	-	-	-	-	-	-	-	-	-	-
c	21,60	25,90	26,10	27,80	29,40	30,70	33,80	31,20	29,10	30,00	29,40	30,00	30,60	24,70
d	10,00	10,40	11,40	12,30	13,00	11,20	11,70	11,20	11,70	9,20	8,60	8,20	7,10	6,50

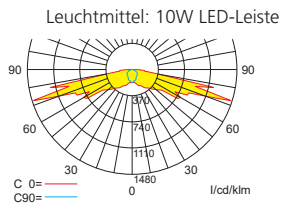

Lampenlichtstrom Not (DC)/Netz: 1.050lm / 1.050lm

h	2,00	3,00	4,00	5,00	6,00	7,00	8,00	9,00	10,00	11,00	12,00
a	-	-	-	-	-	-	-	-	-	-	-
b	-	-	-	-	-	-	-	-	-	-	-
c	21,90	29,60	35,90	37,20	41,80	45,40	45,40	42,30	41,50	40,40	37,40
d	10,00	13,30	14,20	16,30	15,90	15,20	14,50	12,10	10,90	9,10	6,00

Einzelbatteriebeleuchtung

Abstandstabelle ebene Fluchtwege / Tabellenangaben in Meter

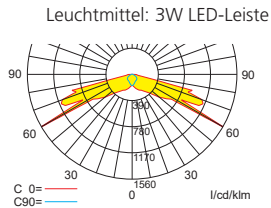

Lampenlichtstrom Not/Netz: 350lm/350lm – Nennbetriebsdauer: 1h/3h

h	2,50	3,00	3,50	4,00	4,50	5,00	5,50	6,00
a	-	-	-	-	-	-	-	-
b	-	-	-	-	-	-	-	-
c	18,50	19,60	20,30	21,90	23,40	23,50	24,70	24,60
d	7,50	8,20	9,10	9,40	9,60	9,40	7,80	6,90

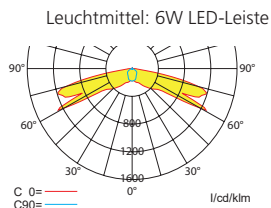

Lampenlichtstrom Not/Netz: 580lm/580lm – Nennbetriebsdauer: 1h/3h

h	2,00	3,00	4,00	5,00	6,00	7,00	8,00	9,00
a	-	-	-	-	-	-	-	-
b	-	-	-	-	-	-	-	-
c	20,56	26,25	30,67	33,68	35,33	35,88	33,93	31,89
d	8,98	11,18	12,39	12,76	12,51	13,94	8,52	0,47

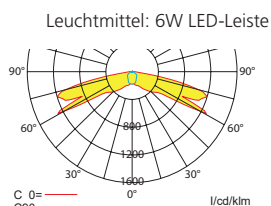

Lampenlichtstrom Not/Netz: 320m/580lm – Nennbetriebsdauer: 8h

h	2,00	3,00	4,00	5,00	6,00
a	-	-	-	-	-
b	-	-	-	-	-
c	18,33	22,89	25,72	26,61	25,38
d	7,84	9,22	9,35	10,08	6,25

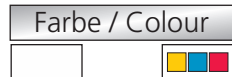

PROTECT BEL-T

Sicherheitsleuchte mit Schutzart IP65 aus Polycarbonat mit klarer Leuchtenhaube, ausgestattet mit Tiefstrahl-Optiken für hohe Deckenhöhen.

Für die ungeschützte Außenmontage bieten wir ein Zubehörset mit Druckausgleichsventil an.

Optional kann die Leuchte als Zentralbatterie-Variante für einen Temperaturbereich bis -35°C geliefert werden (unüberwacht).

Technische Daten

Anschlussklemmen	2 x 2,5 mm ² für Doppelbelegung
Gehäuse/Farbe	Polycarbonat / weiß (Leuchtenhaube klar)
Montageart	Deckenmontage
Abmessungen (B x H x T)	370 x 140 x 93 mm
Schutzart	IP65
Schutzklasse	II

Leuchtmittel	■ Systemleuchten für Zentralversorgung			■ Einzelbatterie-leuchten	
	3W LED-Leiste	6W LED-Leiste	10W LED-Leiste	3W LED-Leiste	6W LED-Leiste
Lichtstrom	350lm	600lm	1.050lm	350lm (Netz)	580lm (Netz)
Nennbetriebsdauer 1h/3h	-	-	-	350lm (Not)	580lm (Not)
Nennbetriebsdauer 8h	-	-	-	-	320lm (Not)
Lichtstromverhältnis					
Not (DC)/Netz 1h/3h	-	-	-	100% / 100%	100% / 100%
Not (DC)/Netz 8h	-	-	-	-	55% / 100%
Netzanschlussleistung	6VA	10,3VA	15VA	6VA	11,5VA
Batterie-Stromaufnahme	19mA	27mA	41mA	-	-
Anschlussspannung	230V 50/60Hz / 220V DC +25/-20%			230V 50/60Hz NiMh-Akku	
NiMh-Akku 1h	-	-	-	4,8V 2,0Ah	4,8V 2,0Ah
NiMh-Akku 3h	-	-	-	4,8V 4,2Ah	4,8V 4,2Ah
NiMh-Akku 8h	-	-	-	-	4,8V 4,2Ah
Temperaturbereich	-10°C bis +40°C			-	-
Bereitschaftsschaltung	-	-	-	-0°C bis +35°C	-
Dauerschaltung	-	-	-	-5°C bis +30°C	-
optional:					
Leuchtschalt- und Überwachungsbaustein	ELC MSÜ3 SET009 SET010 DALI	ELC MSÜ3 SET009 SET010	ELC MSÜ3 SET009 SET010	-	-
Selbstüberwachung	-	-	-	SELF CHECK	
Busüberwachung	-	-	-	SAFELOG Line SAFELOG Wireless	

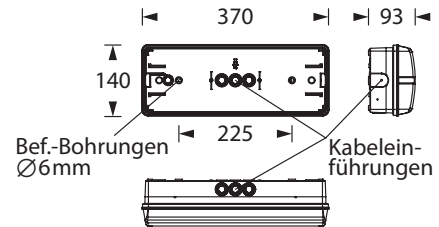

WWW.ELEKTROPLANET.CH
INFO@ELEKTROPLANET.CH

+41 44 950 10 10
+41 44 950 10 44

INDUSTRIESTRASSE 2
CH-8335 HITTLAU

Technische Änderungen vorbehalten/Technical changes reserved

Zubehör

- Ballwurfschutzkorb
- Zentralpendel
- Seilmontageset
- Druckausgleichsventil Zubehörset für ungeschützte Montage

Lichtverteilungskurven und Leuchtenabstandstabellen (E = 1,25 lx)

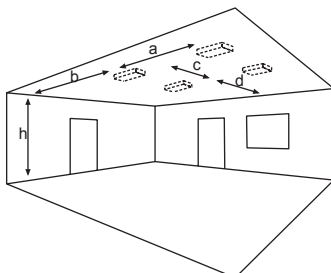

Deckenmontage

Systemleuchten für Zentralversorgung

Abstandstabelle ebene Fluchtwege / Tabellenangaben in Meter

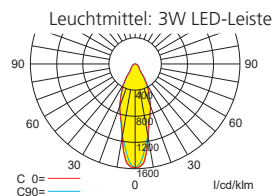

Lampenlichtstrom Not (DC)/Netz: 350lm / 350lm

h	7,00	8,00	9,00	10,00	11,00	12,00	13,00	14,00	15,00	16,00	17,00	18,00	19,00	20,00
a	9,60	10,50	11,20	11,90	12,30	12,60	12,90	13,00	13,10	12,80	12,70	12,20	11,50	11,00
b	4,10	4,40	4,50	4,60	4,60	4,50	4,20	3,90	3,60	3,20	2,80	2,20	1,80	0,90
c	9,60	10,50	11,30	12,00	12,50	12,80	12,90	13,00	12,90	12,70	12,50	12,10	11,50	10,90
d	4,20	4,50	4,50	4,60	4,50	4,40	4,20	3,90	3,40	3,10	3,00	2,60	2,20	1,60

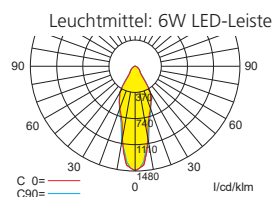

Lampenlichtstrom Not (DC)/Netz: 600lm / 600lm

h	7,00	8,00	9,00	10,00	11,00	12,00	13,00	14,00	15,00	16,00	17,00	18,00	19,00	20,00	21,00	22,00	23,00	24,00
a	11,30	11,90	13,10	14,10	15,00	15,70	16,30	17,10	17,40	17,70	17,70	17,30	16,90	16,30	15,80	15,20	14,30	
b	4,90	5,40	5,70	6,00	6,40	6,30	6,20	6,00	5,70	5,50	5,00	4,70	4,30	4,00	3,90	3,60	2,70	2,40
c	11,40	11,80	12,50	13,60	14,60	15,50	16,30	17,00	17,20	17,50	17,70	17,60	17,20	16,70	16,20	15,40	14,50	13,70
d	4,70	5,20	5,70	6,00	6,40	6,30	6,20	5,90	5,60	5,20	4,80	4,40	3,90	3,80	3,70	3,40	3,00	2,60

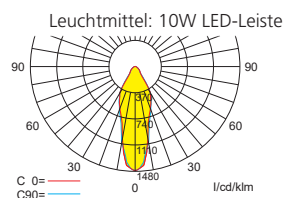

Lampenlichtstrom Not (DC)/Netz: 1.050lm / 1.050lm

h	7,00	9,00	11,00	13,00	15,00	17,00	19,00	21,00	23,00	25,00	27,00	29,00	31,00	33,00
a	13,80	14,80	16,30	18,50	20,20	21,50	22,90	23,40	23,30	23,00	21,90	21,00	19,50	18,30
b	5,30	6,40	7,30	7,90	8,50	8,20	7,70	7,30	6,50	5,80	5,30	4,80	3,40	2,20
c	14,10	14,90	16,00	17,80	19,80	21,50	22,60	23,10	23,30	22,80	21,80	20,50	18,70	17,20
d	5,40	6,20	7,10	7,90	8,50	8,20	7,70	7,00	6,20	5,30	5,00	4,50	3,70	2,90

Einzelbatterieleuchten

Abstandstabelle ebene Fluchtwege / Tabellenangaben in Meter

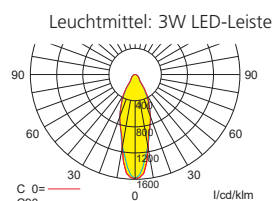

Lampenlichtstrom Not/Netz: 350lm/350lm – Nennbetriebsdauer: 1h/3h

h	7,00	8,00	9,00	10,00	11,00	12,00	13,00	14,00	15,00	16,00	17,00	18,00	19,00	20,00
a	9,60	10,50	11,20	11,90	12,30	12,60	12,90	13,00	13,10	12,80	12,70	12,20	11,50	11,00
b	4,10	4,40	4,50	4,60	4,60	4,50	4,20	3,90	3,60	3,20	2,80	2,20	1,80	0,90
c	9,60	10,50	11,30	12,00	12,50	12,80	12,90	13,00	12,90	12,70	12,50	12,10	11,50	10,90
d	4,20	4,50	4,50	4,60	4,50	4,40	4,20	3,90	3,40	3,10	3,00	2,60	2,20	1,60

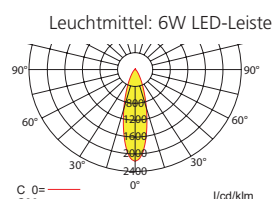

Lampenlichtstrom Not/Netz: 580lm/580lm – Nennbetriebsdauer: 1h/3h

h	7,00	9,00	11,00	13,00	15,00	17,00	19,00	21,00	23,00	25,00	27,00	29,00	31,00
a	11,03	12,25	13,28	14,13	14,82	15,34	15,68	15,97	16,08	16,03	15,89	15,53	15,09
b	4,49	4,96	5,29	5,51	5,65	5,69	5,62	5,44	5,16	4,75	4,16	3,30	1,78
c	11,03	12,25	13,28	14,13	14,82	15,34	15,68	15,97	16,08	16,03	15,89	15,53	15,09
d	4,49	4,96	5,29	5,51	5,65	5,69	5,62	5,44	5,16	4,75	4,16	3,30	1,78

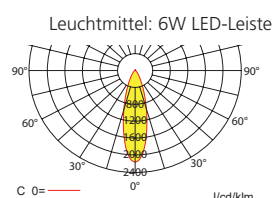

Lampenlichtstrom Not/Netz: 320lm/580lm – Nennbetriebsdauer: 8h

h	7,00	9,00	11,00	13,00	15,00	17,00	19,00	21,00	23,00
a	9,27	10,22	10,96	11,48	11,80	11,94	11,88	11,65	11,21
b	3,74	4,03	4,19	4,21	4,10	3,84	3,41	2,73	1,35
c	9,27	10,22	10,96	11,48	11,80	11,94	11,88	11,65	11,21
d	3,74	4,03	4,19	4,21	4,10	3,84	3,41	2,73	1,35

Lichtverteilungskurven und Leuchtenabstandstabellen (E = 18,75 lx)

Systemleuchten für Zentralversorgung

Abstandstabelle ebene Fluchtwege / Tabellenangaben in Meter

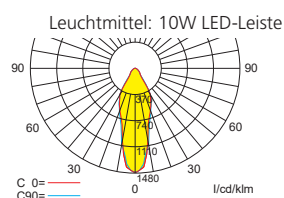

Lampenlichtstrom Not (DC)/Netz: 1.050lm / 1.050lm

h	2,00	3,00	4,00	5,00	6,00	7,00	8,00	9,00
a	3,80	4,40	5,40	6,10	6,30	6,00	5,40	4,70
b	1,50	2,00	2,30	2,10	1,80	1,40	1,10	0,30
c	3,80	4,30	5,30	6,00	6,20	6,00	5,20	4,40
d	1,50	1,90	2,30	2,10	1,70	1,40	1,10	0,30

Einzelbatterieleuchten

Abstandstabelle ebene Fluchtwege / Tabellenangaben in Meter

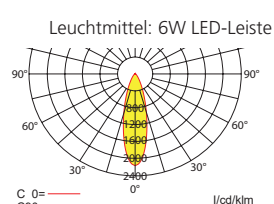

Lampenlichtstrom Not/Netz: 580lm/580lm – Nennbetriebsdauer: 3h

h	4,00	5,00	6,00	7,00	8,00
a	3,90	4,10	4,10	4,10	3,90
b	1,50	1,40	1,30	1,10	0,50
c	3,90	4,10	4,10	4,10	3,90
d	1,50	1,40	1,30	1,10	0,50





BALLWURFSCHUTZKORB WIRE GUARD

Ballwurfschutzkorb für Leuchten zur Wand- und Deckenaufbaumontage

Stabiler Ballwurfschutzkorb aus Stahl-Drahtgeflecht, pulverbeschichtet in weiß. 4 Befestigungslaschen für Wand- oder Deckenmontage.

Der Ballwurfschutzkorb ist als Zubehör separat zu bestellen.

Wire guard for luminaires for wall and ceiling mounting

Stable wire guard made of steel wire mesh, powder-coated in white. 4 fastening lugs for wall or ceiling mounting.

The wire guard has to be ordered separately as accessory.



Leuchte nicht im Lieferumfang enthalten.
Luminaire is not included in the scope of delivery.

Technische Daten / Technical specifications

Drahtgeflecht/ Farbe	weiß
Wire mesh/Colour	white

Bestellangaben / Order information

Abmessungen (B x H x T) / Dimensions (W x H x D)

204 x 225 (ohne Befestigungslaschen) x 75 mm
204 x 225 (without fastening lugs) x 75 mm



Artikelnummer / Item no.

551052

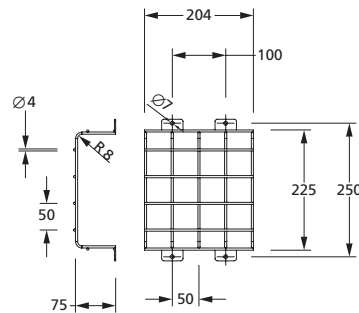

304 x 250 (ohne Befestigungslaschen) x 90 mm
304 x 250 (without fastening lugs) x 90 mm



551053

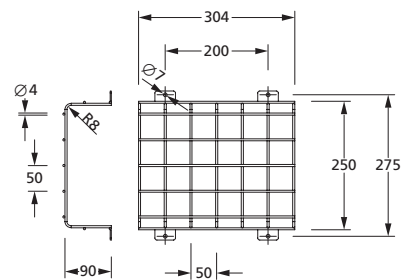

404 x 335 (ohne Befestigungslaschen) x 120 mm
404 x 335 (without fastening lugs) x 120 mm



551054

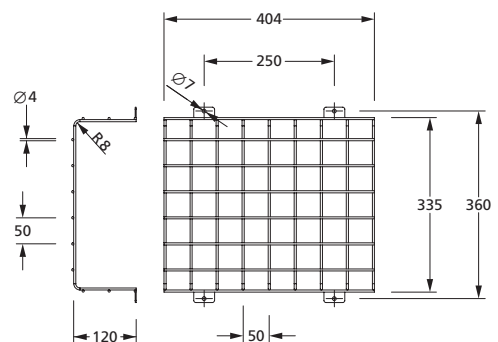



BALLWURFSCHUTZKORB WIRE GUARD

Ballwurfschutzkorb für Leuchten zur Wand- und Deckenaufbaumontage

Stabiler Ballwurfschutzkorb aus verzinktem Drahtgeflecht mit 4 St. flexibel positionierbaren Befestigungshaltern für Rettungszeichen- oder Sicherheitsleuchten.

Der Ballwurfschutzkorb ist als Zubehör separat zu bestellen.

Wire guard for luminaires for wall and ceiling mounting

Stable wire guard made of galvanized wire mesh with 4 pcs mounting brackets which are flexible to position. For exit or safety luminaires.

The wire guard has to be ordered separately as accessory.

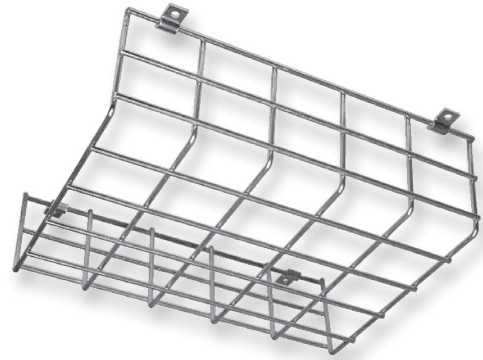

Technische Daten / Technical specifications

Drahtgeflecht/ Farbe verzinkt
Wire mesh/Colour galvanized

Bestellangaben / Order information

Abmessungen (BxHxT) / Dimensions (WxHxD)

406 x 344,4 (ohne Befestigungshalter) x 120 mm
406 x 344,4 (without fixation) x 120 mm

Artikelnummer / Item no.

551003

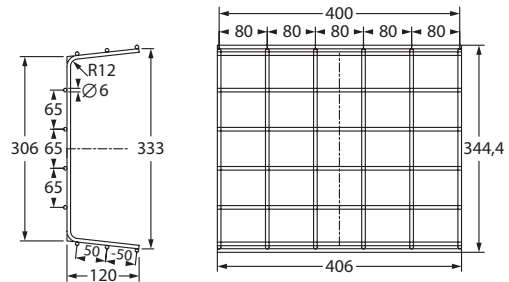
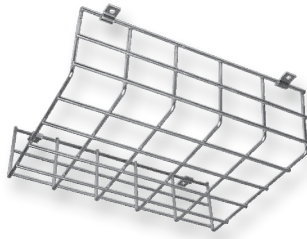

Alle Kreuzungspunkte punktgeschweißt!
All crossing points are spotwelded!

216 x 259 (ohne Befestigungshalter) x 77 mm
216 x 259 (without fixation) x 77 mm

551025

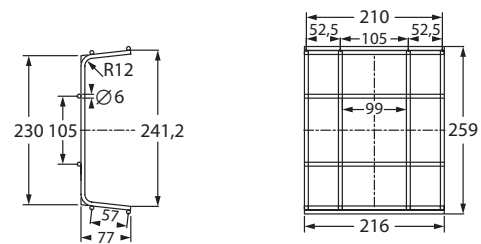
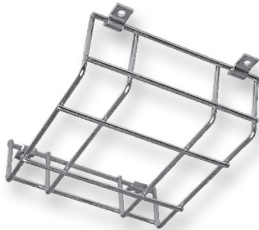

Alle Kreuzungspunkte punktgeschweißt!
All crossing points are spotwelded!

306 x 261 (ohne Befestigungshalter) x 87 mm
306 x 261 (without fixation) x 87 mm

551026

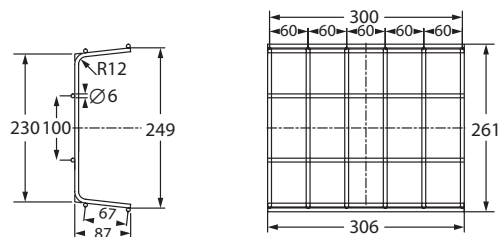
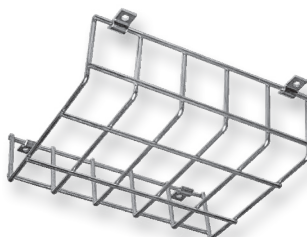

Alle Kreuzungspunkte punktgeschweißt!
All crossing points are spotwelded!



SEILMONTAGE-SETS CABLE ASSEMBLY SETS

Seilmontageset in zwei verschiedenen Längen, ausgestattet mit hochwertigen Grippern und Symmetrierungswinkeln für Leuchten mit asymmetrischer Gewichtsverteilung.

Cable assembly set in two different lengths, equipped with high-quality grippers and symmetry brackets for luminaires with asymmetrical weight distribution.

Technische Daten / Technical specifications

Material	Nickel / Zink Nickel / Zinc
Abmessungen Seil (L) Dimensions Cable (L)	2,5 m oder 7,5 m 2.5 m or 7.5 m
Artikelnummer Item no.	Seilmontageset (incl. 2 x 2,5 m Stahlseil) Cable mounting set (incl. 2 x 2.5 m steel cable) 551042
Artikelnummer Item no.	Seilmontageset (incl. 2 x 7,5 m Stahlseil) Cable mounting set (incl. 2 x 7.5 m steel cable) 551043

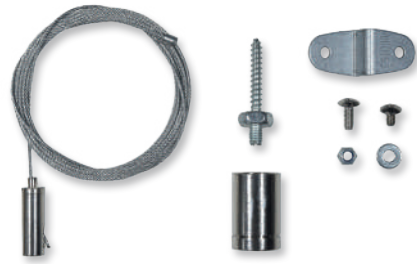

1 Set = 2 Seile mit Anbringungsmaterial
1 Set = 2 cables with mounting material



1 Set = 2 Seile mit Anbringungsmaterial
1 Set = 2 cables with mounting material

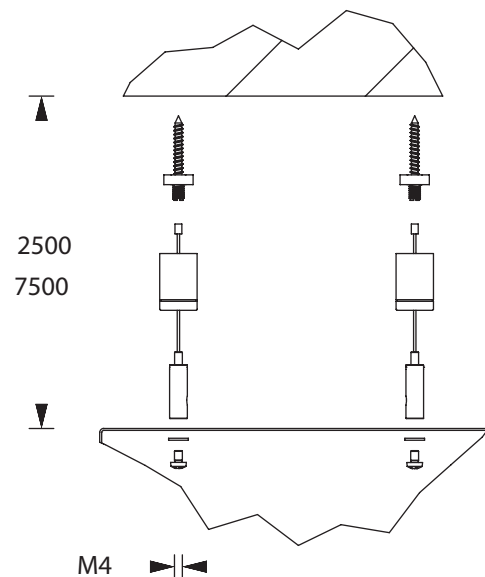



UNIVERSALABDECKPLATTE UNIVERSAL COVER PLATE

Universalabdeckplatte für Deckenausschnitte

Mit der Universalabdeckplatte lassen sich bereits vorhandene Deckenausschnitte abdecken und Leuchten auf oder in der Abdeckplatte montieren. Einfache Leuchtenbefestigung durch vor-geprägte Montageöffnungen.

Nicht verwendbar in Verbindung mit einem Deckeneinbaurahmen.

Universal cover plate for ceiling cutouts

With the universal cover plate, existing ceiling cutouts can be covered and different types of luminaires can be mounted surface or recessed. Easy luminaire mounting due to pre-stamped mounting holes.

Cannot be used in conjunction with a recessed ceiling frame.

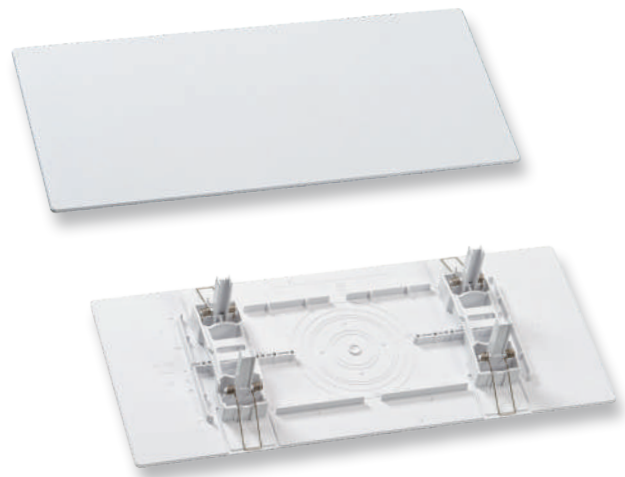

Technische Daten / Technical specifications

Material	Polycarbonat Polycarbonate
Farbe/color	weiß white
Abmessungen (B x H x T) Dimensions (W x H x D)	413 x 69 x 177 mm
Deckenausschnitt (B x H) Ceiling Cutout (W x H)	min. 285 / max. 340 x min. 120 / max. 140 mm

Bestellangaben / Order information

	Artikelnummer / Item no.
Universalabdeckplatte Universal cover plate	551285

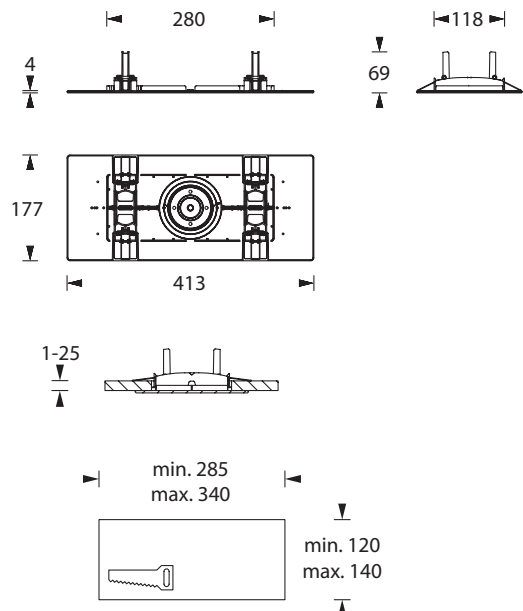



ZENTRALPENDEL-SETS CENTRAL PENDULUM SETS

Zentralpendelset aus Kunststoff mit Vorverdrahtung in drei verschiedenen Längen inkl. steifem Deckenhalter

Plastic central pendulum set with pre-wiring in three different lengths incl. rigid ceiling bracket

Technische Daten Technical specifications

Art.-Nr.
Item no.

Material

Pendel/Baldachin Kunststoff, weiß
Pendulum/Canopy Plastic, white

Abmessungen Pendel 300 mm Dimensions Pendulum 300 mm

(L x Ø) 300 x 13 mm, beidseitig M13
(L x Ø) 300 x 13 mm, on both sides M13 **551038**

Verdrahtung Wiring

(L) 550 mm, Kabel 4-adrig, AWG20,
beidseitig 8 mm abisoliert
(L) 550 mm, 4-wire cable, AWG20,
8 mm stripped on both sides

Abmessungen Pendel 500 mm Dimensions Pendulum 500 mm

(L x Ø) 500 x 13 mm, beidseitig M13
(L x Ø) 500 x 13 mm, on both sides M13 **551039**

Verdrahtung Wiring

(L) 750 mm, Kabel 4-adrig, AWG20,
beidseitig 8 mm abisoliert
(L) 750 mm, 4-wire cable, AWG20,
8 mm stripped on both sides

Abmessungen Pendel 1.000 mm Dimensions length 1.000 mm

(L x Ø) 1.000 x 13 mm, beidseitig M13
(L x Ø) 1.000 x 13 mm, on both sides M13 **551040**

Verdrahtung Wiring

(L) 1.250 mm, Kabel 4-adrig, AWG20,
beidseitig 8 mm abisoliert
(L) 1.250 mm, 4-wire cable, AWG20,
8 mm stripped on both sides

Abmessungen Baldachin Dimensions Canopy

Baldachin (H x Ø) 85 x 60 mm (Außendurchmesser)
Canopy (H x Ø) 85 x 60 mm (outer diameter)

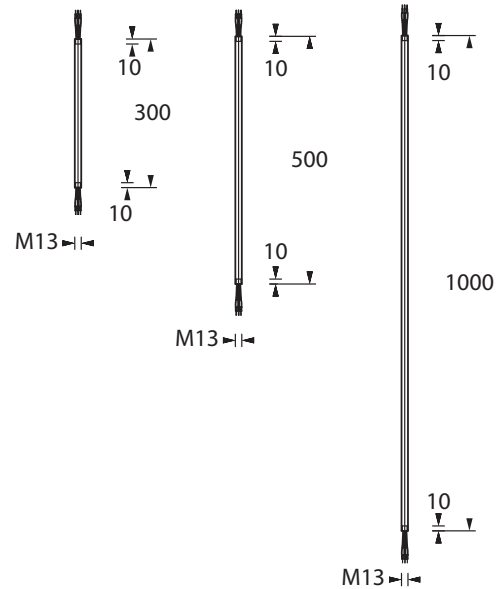

- | | | |
|---|---|----|
|  | 1 - Pendelhaltewinkel
pendulum fixture | 1x |
|  | 2 - Deckenbaldachin
ceiling baldachin | 1x |
|  | 3 - Metallmutter M13
metal nut M13 | 4x |
|  | 4 - Kunststoffmutter M13
plastic nut M13 | 2x |
|  | 5 - Zahnscheibe M13
serrated washer M13 | 2x |
|  | 6 - Aluminium-/ Kunststoffpendel
aluminum-/ plastic pendulum | 1x |
|  | 7 - Ausgleichsscheibe Ø16mm
compensation plate | 1x |
|  | 8 - Ausgleichsscheibe Ø19mm
compensation plate | 2x |



ZENTRALPENDEL-SETS CENTRAL PENDULUM SETS

Zentralpendel-Set aus Aluminium / Kunststoff ohne Vorverdrahtung in drei verschiedenen Längen inkl. steifem Deckenhalter

Aluminum / plastic central pendulum set without pre-wiring in three different lengths incl. rigid ceiling bracket



Technische Daten Technical specifications

Art.-Nr.
Item no.

Material

Pendel	Aluminium
Pendulum	Aluminum
Baldachin	Kunststoff, weiß
Canopy	Plastic, white

Abmessungen Pendel 300 mm Dimensions Pendulum 300 mm

(L x Ø)	300 x 13 mm, beidseitig M13	551008
(L x Ø)	300 x 13 mm, on both sides M13	

Abmessungen Pendel 500 mm Dimensions Pendulum 500 mm

(L x Ø)	500 x 13 mm, beidseitig M13	551009
(L x Ø)	500 x 13 mm, on both sides M13	

Abmessungen Pendel 1.000 mm Dimensions length 1.000 mm

(L x Ø)	1.000 x 13 mm, beidseitig M13	551010
(L x Ø)	1.000 x 13 mm, on both sides M13	

Abmessungen Baldachin Dimensions Canopy

Baldachin (H x Ø)	85 x 60 mm (Außendurchmesser)
Canopy (H x Ø)	85 x 60 mm (outer diameter)

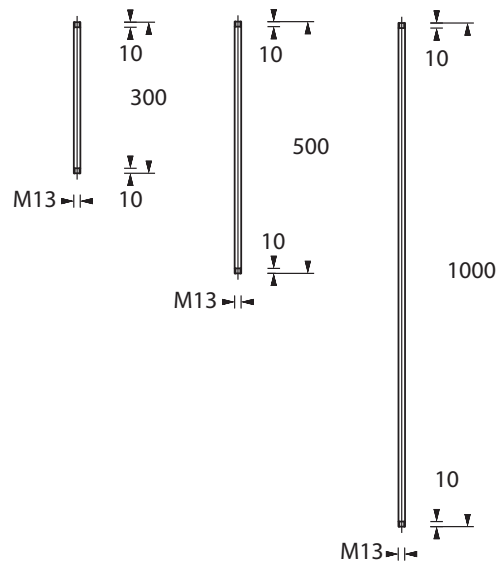

	1 - Pendelhaltewinkel pendulum fixture	1x
	2 - Deckenbaldachin ceiling baldachin	1x
	3 - Metallmutter M13 metal nut M13	4x
	4 - Kunststoffmutter M13 plastic nut M13	2x
	5 - Zahnscheibe M13 serrated washer M13	2x
	6 - Aluminium-/ Kunststoffpendel aluminum-/ plastic pendulum	1x
	7 - Ausgleichsscheibe Ø16mm compensation plate	1x
	8 - Ausgleichsscheibe Ø19mm compensation plate	2x

PROTECT BEL Wand-/Deckenmontage



- Sicherheitsleuchte zur Flächenausleuchtung.
- Die Leuchte entspricht dem IFS (International Food Standard) und ist auf die Schlagfestigkeit IK08 geprüft.
- Die Leuchte ist ballwurfsicher DIN 18032-3.
- Die 10W-Variante verfügt über einen Aluminium-Kühlkörper.
- Für die ungeschützte Außenmontage kann die Leuchte optional mit einem Druckausgleichsventil ausgestattet werden. In den Versionen mit Akkuheizung und externer Versorgung ist das Druckausgleichsventil immer in der Leuchte integriert.
- Gegen Aufpreis ist die Leuchte in der 1,5W-Variante für Zentralbatterie-Nennspannungen von **24V**, **48/60V** und **110V**, die 3W und 6W-Varianten für **24V** und **110V** und die 10W-Variante für **24V** erhältlich.
- Anschlussklemmen: 2 x 2,5 mm² für Doppelbelegung
- Gehäuse: Polycarbonat (Leuchtenhaube klar)
- Farbe: weiß
- Abmessungen (B x H x T): 370 x 140 x 93 mm
- Schutzart: IP65
- Schutzklasse: II

■ Systemleuchten für Zentralversorgung

Technische Daten

Anschlussspannung 230V 50/60Hz, 220V DC +25/-20% Temperaturbereich -10°C bis +40°C

Bestelldaten

Bestell-Nr.	Bezeichnung	Leuchtmittel	Lichtstrom	Netzanschlussleistung	Batteriestromaufnahme
101315	PROTECT BEL WM/DM LED	1,5W LED-Leiste	190lm	5VA	12mA
101315-ELC	PROTECT BEL WM/DM LED + ELC	1,5W LED-Leiste	190lm	5,5VA	12mA
101315-MSÜ	PROTECT BEL WM/DM LED + MSÜ3	1,5W LED-Leiste	190lm	5,5VA	12mA
101315-SE	PROTECT BEL WM/DM LED + SET009	1,5W LED-Leiste	190lm	5,5VA	12mA
101315-ST	PROTECT BEL WM/DM LED + SET010	1,5W LED-Leiste	190lm	5,5VA	12mA
101320	PROTECT BEL WM/DM LED	3W LED-Leiste	350lm	6VA	19mA
101320-DA	PROTECT BEL WM/DM LED + DALI	3W LED-Leiste	350lm	6VA	19mA
101320-ELC	PROTECT BEL WM/DM LED + ELC	3W LED-Leiste	350lm	6,5VA	19mA
101320-MSÜ	PROTECT BEL WM/DM LED + MSÜ3	3W LED-Leiste	350lm	6,5VA	19mA
101320-SE	PROTECT BEL WM/DM LED + SET009	3W LED-Leiste	350lm	6,5VA	19mA
101320-ST	PROTECT BEL WM/DM LED + SET010	3W LED-Leiste	350lm	6,5VA	19mA
101325	PROTECT BEL WM/DM LED	6W LED-Leiste	600lm	10,3VA	27mA
101325-ELC	PROTECT BEL WM/DM LED + ELC	6W LED-Leiste	600lm	10,8VA	27mA
101325-MSÜ	PROTECT BEL WM/DM LED + MSÜ3	6W LED-Leiste	600lm	10,8VA	27mA
101325-SE	PROTECT BEL WM/DM LED + SET009	6W LED-Leiste	600lm	10,8VA	27mA
101325-ST	PROTECT BEL WM/DM LED + SET010	6W LED-Leiste	600lm	10,8VA	27mA
101330	PROTECT BEL WM/DM LED	10W LED-Leiste	1.050lm	15VA	41mA
101330-ELC	PROTECT BEL WM/DM LED + ELC	10W LED-Leiste	1.050lm	15,5VA	41mA
101330-MSÜ	PROTECT BEL WM/DM LED + MSÜ3	10W LED-Leiste	1.050lm	15,5VA	41mA
101330-SE	PROTECT BEL WM/DM LED + SET009	10W LED-Leiste	1.050lm	15,5VA	41mA
101330-ST	PROTECT BEL WM/DM LED + SET010	10W LED-Leiste	1.050lm	15,5VA	41mA

■ Einzelbatterieeleuchten

Technische Daten

Anschlussspannung 230V 50/60Hz Temperaturbereich BS 0°C bis +35°C
 NiMh-Akku 4,8V 2,0Ah (Best.-Nr. 570008) (1h+3h) / 4,8V 4,2Ah (Best.-Nr. 570006) (8h) = 1,5W LED-Leiste Temperaturbereich DS -5°C bis +30°C
 4,8V 2,0Ah (Best.-Nr. 570008) (1h) / 4,8V 4,2Ah (Best.-Nr. 570006) (3h) = 3W LED-Leiste
 4,8V 2,0Ah (Best.-Nr. 570008) (1h) / 4,8V 4,2Ah (Best.-Nr. 570006) (3h+8h) = 6W LED-Leiste
 4,8V 4,2Ah (Best.-Nr. 570010) (3h+8h) für Heizungscontainer
 Lichtstromverhältnis 100% / 100 % Not/Netz (1h+3h+8h) = 1,5W LED-Leiste (1h + 3h) = 3W + 6W LED-Leiste
 55% / 100 % Not/Netz (8h) = 6W LED-Leiste

Bestelldaten

Bestell-Nr.	Bezeichnung	Leuchtmittel	Lichtstrom Netzbetrieb	Lichtstrom Notbetrieb	Netzanschlussleistung	Nennbetriebsdauer
Standardausführung						
201316	PROTECT BEL WM/DM EB LED	1,5W LED-Leiste	190lm	190lm	5VA	1h
201316-SC	PROTECT BEL WM/DM EB-SC LED	1,5W LED-Leiste	190lm	190lm	5VA	1h
201316-SL	PROTECT BEL WM/DM EB-SL LED	1,5W LED-Leiste	190lm	190lm	5VA	1h
201316-SWX	PROTECT BEL WM/DM EB-SWX LED	1,5W LED-Leiste	190lm	190lm	5,5VA	1h
201321	PROTECT BEL WM/DM EB LED	3W LED-Leiste	350lm	350lm	6VA	1h
201321-SC	PROTECT BEL WM/DM EB-SC LED	3W LED-Leiste	350lm	350lm	6VA	1h
201321-SL	PROTECT BEL WM/DM EB-SL LED	3W LED-Leiste	350lm	350lm	6VA	1h
201321-SWX	PROTECT BEL WM/DM EB-SWX LED	3W LED-Leiste	350lm	350lm	6,5VA	1h
201322	PROTECT BEL WM/DM EB LED	6W LED-Leiste	580lm	580lm	11,5VA	1h
201322-SC	PROTECT BEL WM/DM EB-SC LED	6W LED-Leiste	580lm	580lm	11,5VA	1h
201322-SL	PROTECT BEL WM/DM EB-SL LED	6W LED-Leiste	580lm	580lm	11,5VA	1h



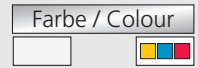

PROTECT BEL Wand-/Deckenmontage

Bestelldaten						
Bestell-Nr.	Bezeichnung	Leuchtmittel	Lichtstrom Netzbetrieb	Lichtstrom Notbetrieb	Netzanschluss- leistung	Nennbe- triebsdauer
Standardausführung						
201322-SWX	PROTECT BEL WM/DM EB-SWX LED	6W LED-Leiste	580lm	580lm	12VA	1h
201315	PROTECT BEL WM/DM EB LED	1,5W LED-Leiste	190lm	190lm	5VA	3h
201315-SC	PROTECT BEL WM/DM EB-SC LED	1,5W LED-Leiste	190lm	190lm	5VA	3h
201315-SL	PROTECT BEL WM/DM EB-SL LED	1,5W LED-Leiste	190lm	190lm	5VA	3h
201315-SWX	PROTECT BEL WM/DM EB-SWX LED	1,5W LED-Leiste	190lm	190lm	5,5VA	3h
201320	PROTECT BEL WM/DM EB LED	3W LED-Leiste	350lm	350lm	6VA	3h
201320-SC	PROTECT BEL WM/DM EB-SC LED	3W LED-Leiste	350lm	350lm	6VA	3h
201320-SL	PROTECT BEL WM/DM EB-SL LED	3W LED-Leiste	350lm	350lm	6VA	3h
201320-SWX	PROTECT BEL WM/DM EB-SWX LED	3W LED-Leiste	350lm	350lm	6,5VA	3h
201323	PROTECT BEL WM/DM EB LED	6W LED-Leiste	580lm	580lm	11,5VA	3h
201323-SC	PROTECT BEL WM/DM EB-SC LED	6W LED-Leiste	580lm	580lm	11,5VA	3h
201323-SL	PROTECT BEL WM/DM EB-SL LED	6W LED-Leiste	580lm	580lm	11,5VA	3h
201323-SWX	PROTECT BEL WM/DM EB-SWX LED	6W LED-Leiste	580lm	580lm	12VA	3h
201317	PROTECT BEL WM/DM EB LED	1,5W LED-Leiste	190lm	190lm	5VA	8h
201317-SC	PROTECT BEL WM/DM EB-SC LED	1,5W LED-Leiste	190lm	190lm	5VA	8h
201317-SL	PROTECT BEL WM/DM EB-SL LED	1,5W LED-Leiste	190lm	190lm	5VA	8h
201317-SWX	PROTECT BEL WM/DM EB-SWX LED	1,5W LED-Leiste	190lm	190lm	5,5VA	8h
201324	PROTECT BEL WM/DM EB LED	6W LED-Leiste	580lm	320lm	11,5VA	8h
201324-SC	PROTECT BEL WM/DM EB-SC LED	6W LED-Leiste	580lm	320lm	11,5VA	8h
201324-SL	PROTECT BEL WM/DM EB-SL LED	6W LED-Leiste	580lm	320lm	11,5VA	8h
201324-SWX	PROTECT BEL WM/DM EB-SWX LED	6W LED-Leiste	580lm	320lm	12VA	8h

Bestelldaten						
Bestell-Nr.	Bezeichnung	Leuchtmittel	Lichtstrom Netzbetrieb	Lichtstrom Notbetrieb	Netzanschluss- leistung	Nennbe- triebsdauer
mit Akkuheizung Temperaturbereich BS -20°C bis +35°C / DS -20°C bis +30°C						
201306	PROTECT BEL WM/DM EB LED + AkH	3W LED-Leiste	350lm	350lm	6VA	3h
201306-SC	PROTECT BEL WM/DM EB-SC LED + AkH	3W LED-Leiste	350lm	350lm	6VA	3h
201306-SL	PROTECT BEL WM/DM EB-SL LED + AkH	3W LED-Leiste	350lm	350lm	6VA	3h
201306-SWX	PROTECT BEL WM/DM EB-SWX LED + AkH	3W LED-Leiste	350lm	350lm	6,5VA	3h
201325	PROTECT BEL WM/DM EB LED + AkH	6W LED-Leiste	580lm	580lm	11,5VA	3h
201325-SC	PROTECT BEL WM/DM EB-SC LED + AkH	6W LED-Leiste	580lm	580lm	11,5VA	3h
201325-SL	PROTECT BEL WM/DM EB-SL LED + AkH	6W LED-Leiste	580lm	580lm	11,5VA	3h
201325-SWX	PROTECT BEL WM/DM EB-SWX LED + AkH	6W LED-Leiste	580lm	580lm	12VA	3h
201309	PROTECT BEL WM/DM EB LED + AkH	1,5W LED-Leiste	190lm	190lm	5VA	8h
201309-SC	PROTECT BEL WM/DM EB-SC LED + AkH	1,5W LED-Leiste	190lm	190lm	5VA	8h
201309-SL	PROTECT BEL WM/DM EB-SL LED + AkH	1,5W LED-Leiste	190lm	190lm	5VA	8h
201309-SWX	PROTECT BEL WM/DM EB-SWX LED + AkH	1,5W LED-Leiste	190lm	190lm	5,5VA	8h
201326	PROTECT BEL WM/DM EB LED + AkH	6W LED-Leiste	580lm	320lm	11,5VA	8h
201326-SC	PROTECT BEL WM/DM EB-SC LED + AkH	6W LED-Leiste	580lm	320lm	11,5VA	8h
201326-SL	PROTECT BEL WM/DM EB-SL LED + AkH	6W LED-Leiste	580lm	320lm	11,5VA	8h
201326-SWX	PROTECT BEL WM/DM EB-SWX LED + AkH	6W LED-Leiste	580lm	320lm	12VA	8h

Bestelldaten						
Bestell-Nr.	Bezeichnung	Leuchtmittel	Lichtstrom Netzbetrieb	Lichtstrom Notbetrieb	Netzanschluss- leistung	Nennbe- triebsdauer
mit externer Versorgung Temperaturbereich BS -35°C bis +35°C / DS -35°C bis +30°C						
201310	PROTECT BEL WM/DM EB LED + ExV	1,5W LED-Leiste	190lm	190lm	5VA	1h
201310-SC	PROTECT BEL WM/DM EB-SC LED + ExV	1,5W LED-Leiste	190lm	190lm	5VA	1h
201310-SL	PROTECT BEL WM/DM EB-SL LED + ExV	1,5W LED-Leiste	190lm	190lm	5VA	1h
201310-SWX	PROTECT BEL WM/DM EB-SWX LED + ExV	1,5W LED-Leiste	190lm	190lm	5,5VA	1h
201311	PROTECT BEL WM/DM EB LED + ExV	3W LED-Leiste	350lm	350lm	6VA	1h
201311-SC	PROTECT BEL WM/DM EB-SC LED + ExV	3W LED-Leiste	350lm	350lm	6VA	1h
201311-SL	PROTECT BEL WM/DM EB-SL LED + ExV	3W LED-Leiste	350lm	350lm	6VA	1h
201311-SWX	PROTECT BEL WM/DM EB-SWX LED + ExV	3W LED-Leiste	350lm	350lm	6,5VA	1h
201327	PROTECT BEL WM/DM EB LED + ExV	6W LED-Leiste	580lm	580lm	11,5VA	1h
201327-SC	PROTECT BEL WM/DM EB-SC LED + ExV	6W LED-Leiste	580lm	580lm	11,5VA	1h
201327-SL	PROTECT BEL WM/DM EB-SL LED + ExV	6W LED-Leiste	580lm	580lm	11,5VA	1h
201327-SWX	PROTECT BEL WM/DM EB-SWX LED + ExV	6W LED-Leiste	580lm	580lm	12VA	1h
201307	PROTECT BEL WM/DM EB LED + ExV	1,5W LED-Leiste	190lm	190lm	5VA	3h
201307-SC	PROTECT BEL WM/DM EB-SC LED + ExV	1,5W LED-Leiste	190lm	190lm	5VA	3h
201307-SL	PROTECT BEL WM/DM EB-SL LED + ExV	1,5W LED-Leiste	190lm	190lm	5VA	3h
201307-SWX	PROTECT BEL WM/DM EB-SWX LED + ExV	1,5W LED-Leiste	190lm	190lm	5,5VA	3h
201303	PROTECT BEL WM/DM EB LED + ExV	3W LED-Leiste	350lm	350lm	6VA	3h



PROTECT BEL Wand-/Deckenmontage

Bestelldaten

Bestell-Nr.	Bezeichnung	Leuchtmittel	Lichtstrom Netzbetrieb	Lichtstrom Notbetrieb	Netzanschluss- leistung	Nennbe- triebsdauer
mit externer Versorgung Temperaturbereich BS -35°C bis +35°C / DS -35°C bis +30°C						
201303-SC	PROTECT BEL WM/DM EB-SC LED + ExV	3W LED-Leiste	350lm	350lm	6VA	3h
201303-SL	PROTECT BEL WM/DM EB-SL LED + ExV	3W LED-Leiste	350lm	350lm	6VA	3h
201303-SWX	PROTECT BEL WM/DM EB-SWX LED + ExV	3W LED-Leiste	350lm	350lm	6,5VA	3h
201328	PROTECT BEL WM/DM EB LED + ExV	6W LED-Leiste	580lm	580lm	11,5VA	3h
201328-SC	PROTECT BEL WM/DM EB-SC LED + ExV	6W LED-Leiste	580lm	580lm	11,5VA	3h
201328-SL	PROTECT BEL WM/DM EB-SL LED + ExV	6W LED-Leiste	580lm	580lm	11,5VA	3h
201328-SWX	PROTECT BEL WM/DM EB-SWX LED + ExV	6W LED-Leiste	580lm	580lm	12VA	3h
201308	PROTECT BEL WM/DM EB LED + ExV	1,5W LED-Leiste	190lm	190lm	5VA	8h
201308-SC	PROTECT BEL WM/DM EB-SC LED + ExV	1,5W LED-Leiste	190lm	190lm	5VA	8h
201308-SL	PROTECT BEL WM/DM EB-SL LED + ExV	1,5W LED-Leiste	190lm	190lm	5VA	8h
201308-SWX	PROTECT BEL WM/DM EB-SWX LED + ExV	1,5W LED-Leiste	190lm	190lm	5,5VA	8h
201329	PROTECT BEL WM/DM EB LED + ExV	6W LED-Leiste	580lm	320lm	11,5VA	8h
201329-SC	PROTECT BEL WM/DM EB-SC LED + ExV	6W LED-Leiste	580lm	320lm	11,5VA	8h
201329-SL	PROTECT BEL WM/DM EB-SL LED + ExV	6W LED-Leiste	580lm	320lm	11,5VA	8h
201329-SWX	PROTECT BEL WM/DM EB-SWX LED + ExV	6W LED-Leiste	580lm	320lm	12VA	8h

Zubehör Systemleuchten und Einzelbatterieleuchten

Bestell-Nr.	Bezeichnung	Anmerkung	siehe Zubehör
550237	Druckausgleichsventil Zubehör-Set		S. 350
551038	Zentralpendel 300 mm (mit Vorverdrahtung)		S. 343
551039	Zentralpendel 500 mm (mit Vorverdrahtung)		S. 343
551040	Zentralpendel 1000 mm (mit Vorverdrahtung)		S. 343
551042	Seilmontageset, 2 x 2,5 Meter		S. 344
551043	Seilmontageset, 2 x 7,5 Meter		S. 344
551284	Mast- und Wandhalterung IMPACT & PROTECT, schwenkbar		S. 347
551285	Universalabdeckplatte für Deckenausschnitte		S. 343

Lichtverteilungskurven und Leuchtenabstandstabellen (E = 1,25 lx)

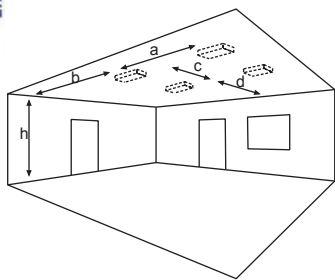

Systemleuchten für Zentralversorgung

Abstandstabelle ebene Fluchtwege / Tabellenangaben in Meter

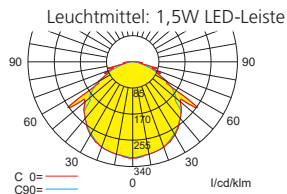

Lampenlichtstrom Not (DC)/Netz: 190lm / 190lm

	h	a	b	c	d
h	2,50	3,00	3,50	4,00	4,50
a	7,90	8,50	8,90	9,00	9,30
b	3,15	3,20	3,40	3,30	3,30
c	7,70	9,00	9,50	9,50	9,60
d	3,60	3,40	3,40	3,30	3,30

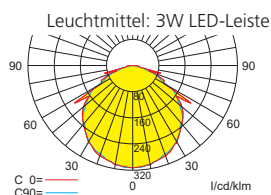

Lampenlichtstrom Not (DC)/Netz: 350lm / 350lm

	h	a	b	c	d
h	2,50	3,00	3,50	4,00	4,50
a	9,20	10,20	11,00	11,50	11,90
b	3,90	4,10	4,30	4,50	4,60
c	9,20	10,20	11,50	11,90	12,70
d	4,10	4,70	4,40	4,60	4,60



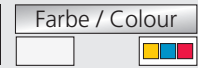

PROTECT BEL Wand-/Deckenmontage

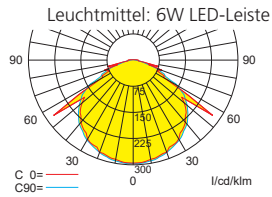

Lampenlichtstrom Not (DC)/Netz: 600lm / 600lm

h	2,00	3,00	4,00	5,00	6,00	7,00	8,00	9,00	10,00	11,00	12,00
a	9,60	11,80	14,00	15,30	16,30	16,90	17,10	17,20	17,00	16,40	15,60
b	4,00	5,00	5,60	5,90	6,00	5,90	5,70	5,20	4,40	3,20	2,20
c	9,70	11,50	13,30	15,60	16,60	16,60	16,80	16,80	16,70	16,10	15,10
d	3,80	4,80	6,00	5,80	5,90	5,90	5,60	5,10	4,20	3,00	2,80

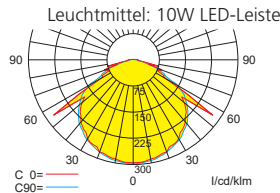

Lampenlichtstrom Not (DC)/Netz: 1.050lm / 1.050lm

h	2,00	3,00	4,00	5,00	6,00	7,00	8,00	9,00	10,00	11,00	12,00	13,00	14,00	15,00
a	10,10	13,60	15,30	17,60	19,20	20,40	21,10	21,70	21,90	22,10	21,90	21,70	21,00	20,30
b	4,30	5,50	6,60	7,20	7,50	7,70	7,80	7,70	7,40	7,00	6,30	5,50	4,20	2,00
c	10,40	12,80	15,10	16,80	19,10	20,80	21,80	21,20	21,50	21,70	21,40	21,30	20,70	19,80
d	4,00	5,30	6,50	7,60	7,30	7,60	7,60	7,50	7,30	6,80	6,30	5,20	4,00	1,70

Einzelbatterieleuchten

Abstandstabelle ebene Fluchtwege / Tabellenangaben in Meter

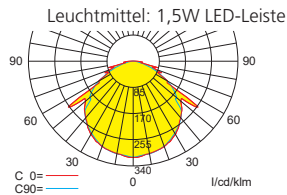

Lampenlichtstrom Not/Netz: 190lm/190lm – Nennbetriebsdauer: 1h/3h/8h

h	2,50	3,00	3,50	4,00	4,50	5,00	5,50	6,00	6,50	7,00	7,50	8,00
a	7,90	8,50	8,90	9,00	9,30	9,60	9,50	9,40	9,10	8,70	7,50	6,20
b	3,15	3,20	3,40	3,30	3,30	3,10	2,80	2,50	2,00	1,30	0,50	0,40
c	7,70	9,00	9,50	9,50	9,60	9,70	9,60	9,40	9,10	8,70	7,50	6,20
d	3,60	3,40	3,40	3,30	3,30	3,20	2,90	2,50	2,00	1,50	0,50	0,50

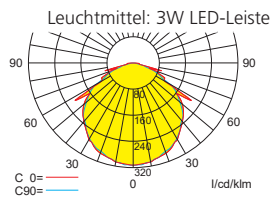

Lampenlichtstrom Not/Netz: 350lm/350lm – Nennbetriebsdauer: 1h/3h

h	2,50	3,00	3,50	4,00	4,50	5,00	5,50	6,00	6,50	7,00	7,50	8,00	8,50	9,00	9,50	10,00
a	9,20	10,20	11,00	11,50	11,90	12,20	12,50	12,70	12,80	12,70	12,40	12,20	11,90	11,50	10,50	
b	3,90	4,10	4,30	4,50	4,60	4,60	4,50	4,40	4,30	4,10	3,80	3,40	2,90	2,30	1,80	1,00
c	9,20	10,20	11,50	11,90	12,70	12,40	12,80	12,90	13,00	12,90	12,80	12,60	12,30	12,00	11,60	10,80
d	4,10	4,70	4,40	4,60	4,60	4,60	4,60	4,40	4,30	4,10	3,80	3,50	3,00	2,60	1,90	1,00

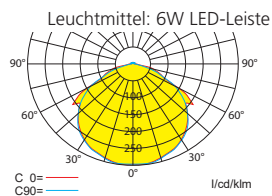

Lampenlichtstrom Not/Netz: 580lm/580lm – Nennbetriebsdauer: 1h/3h

h	2,00	3,00	4,00	5,00	6,00	7,00	8,00	9,00	10,00	11,00
a	9,89	12,21	14,05	15,22	16,13	16,71	16,96	17,04	16,9	16,38
b	4,17	5,08	5,6	5,91	6,01	5,98	5,71	5,17	4,38	3,05
c	10,08	12,07	14,42	16,13	16,78	16,67	17	16,97	16,74	16,21
d	4,13	5,29	5,96	5,9	6,01	5,93	5,65	5,14	4,32	2,98

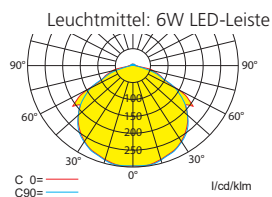

Lampenlichtstrom Not/Netz: 320lm/580lm – Nennbetriebsdauer: 8h

h	2,00	3,00	4,00	5,00	6,00	7,00	8,00
a	8,51	10,48	11,6	12,31	12,61	12,64	12,27
b	3,61	4,17	4,43	4,46	4,22	3,64	2,5
c	8,45	10,77	12,31	12,3	12,63	12,55	12,14
d	3,66	4,44	4,44	4,43	4,17	3,61	2,48



PROTECT BEL-R Deckenmontage

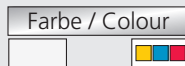

- Leuchte mit Optiken zur Fluchtwegausleuchtung.
- Die Leuchte entspricht dem IFS (International Food Standard) und ist auf die Schlagfestigkeit IK08 geprüft.
- Die Leuchte ist ballwurfsicher DIN 18032-3.
- Die 10W-Variante verfügt über einen Aluminium-Kühlkörper.
- Für die ungeschützte Außenmontage kann die Leuchte optional mit einem Druckausgleichsventil ausgestattet werden. In den Versionen mit Akkuheizung und externer Versorgung ist das Druckausgleichsventil immer in der Leuchte integriert.
- **ACHTUNG!** Bei Rettungswegausleuchtung Montagerichtung beachten (s. Bild)!
- Gegen Aufpreis ist die Leuchte in der 3W und 6W-Variante für Zentralbatterie-Nennspannungen von **24V** und **110V** und in der 10W-Variante für **24V** erhältlich.
- Anschlussklemmen: 2 x 2,5 mm² für Doppelbelegung
- Gehäuse: Polycarbonat (Leuchtenhaube klar)
- Farbe: weiß
- Abmessungen (B x H x T): 370 x 140 x 93 mm
- Schutzart: IP65
- Schutzklasse: II

Systemleuchten für Zentralversorgung

Technische Daten

Anschlussspannung 230V 50/60Hz, 220V DC +25/-20% Temperaturbereich -10°C bis +40°C

Bestelldaten

Bestell-Nr.	Bezeichnung	Leuchtmittel	Lichtstrom	Netzanschlussleistung	Batteriestromaufnahme
101335	PROTECT BEL-R DM LED	3W LED-Leiste	350lm	6VA	19mA
101335-DA	PROTECT BEL-R DM LED + DALI	3W LED-Leiste	350lm	6VA	19mA
101335-ELC	PROTECT BEL-R DM LED + ELC	3W LED-Leiste	350lm	6,5VA	19mA
101335-MSÜ	PROTECT BEL-R DM LED + MSÜ3	3W LED-Leiste	350lm	6,5VA	19mA
101335-SE	PROTECT BEL-R DM LED + SET009	3W LED-Leiste	350lm	6,5VA	19mA
101335-ST	PROTECT BEL-R DM LED + SET010	3W LED-Leiste	350lm	6,5VA	19mA
101340	PROTECT BEL-R DM LED	6W LED-Leiste	600lm	10,3VA	27mA
101340-ELC	PROTECT BEL-R DM LED + ELC	6W LED-Leiste	600lm	10,8VA	27mA
101340-MSÜ	PROTECT BEL-R DM LED + MSÜ3	6W LED-Leiste	600lm	10,8VA	27mA
101340-SE	PROTECT BEL-R DM LED + SET009	6W LED-Leiste	600lm	10,8VA	27mA
101340-ST	PROTECT BEL-R DM LED + SET010	6W LED-Leiste	600lm	10,8VA	27mA
101345	PROTECT BEL-R DM LED	10W LED-Leiste	1.050lm	15VA	41mA
101345-ELC	PROTECT BEL-R DM LED + ELC	10W LED-Leiste	1.050lm	15,5VA	41mA
101345-MSÜ	PROTECT BEL-R DM LED + MSÜ3	10W LED-Leiste	1.050lm	15,5VA	41mA
101345-SE	PROTECT BEL-R DM LED + SET009	10W LED-Leiste	1.050lm	15,5VA	41mA
101345-ST	PROTECT BEL-R DM LED + SET010	10W LED-Leiste	1.050lm	15,5VA	41mA

Einzelbatterieleuchten

Technische Daten

Anschlussspannung 230V 50/60Hz Temperaturbereich BS 0°C bis +35°C
 NiMh-Akku 4,8V 2,0Ah (Best.-Nr. 570008) (1h) / 4,8V 4,2Ah (Best.-Nr. 570006) (3h) = 3W LED-Leiste Temperaturbereich DS -5°C bis +30°C
 4,8V 2,0Ah (Best.-Nr. 570008) (1h) / 4,8V 4,2Ah (Best.-Nr. 570006) (3h+8h) = 6W LED-Leiste
 4,8V 4,2Ah (Best.-Nr. 570010) (3h+8h) für Heizungscontainer
 Lichtstromverhältnis 100% / 100 % Not/Netz (1h+3h) = 3W + 6W LED-Leiste
 55% / 100 % Not/Netz (8h) = 6W LED-Leiste

Bestelldaten

Bestell-Nr.	Bezeichnung	Leuchtmittel	Lichtstrom Netzbetrieb	Lichtstrom Notbetrieb	Netzanschlussleistung	Nennbetriebsdauer
Standardausführung						
201336	PROTECT BEL-R DM EB LED	3W LED-Leiste	350lm	350lm	6VA	1h
201336-SC	PROTECT BEL-R DM EB-SC LED	3W LED-Leiste	350lm	350lm	6VA	1h
201336-SL	PROTECT BEL-R DM EB-SL LED	3W LED-Leiste	350lm	350lm	6VA	1h
201336-SWX	PROTECT BEL-R DM EB-SWX LED	3W LED-Leiste	350lm	350lm	6,5VA	1h
201352	PROTECT BEL-R DM EB LED	6W LED-Leiste	580lm	580lm	11,5VA	1h
201352-SC	PROTECT BEL-R DM EB-SC LED	6W LED-Leiste	580lm	580lm	11,5VA	1h
201352-SL	PROTECT BEL-R DM EB-SL LED	6W LED-Leiste	580lm	580lm	11,5VA	1h
201352-SWX	PROTECT BEL-R DM EB-SWX LED	6W LED-Leiste	580lm	580lm	12VA	1h
201335	PROTECT BEL-R DM EB LED	3W LED-Leiste	350lm	350lm	6VA	3h
201335-SC	PROTECT BEL-R DM EB-SC LED	3W LED-Leiste	350lm	350lm	6VA	3h
201335-SL	PROTECT BEL-R DM EB-SL LED	3W LED-Leiste	350lm	350lm	6VA	3h
201335-SWX	PROTECT BEL-R DM EB-SWX LED	3W LED-Leiste	350lm	350lm	6,5VA	3h
201353	PROTECT BEL-R DM EB LED	6W LED-Leiste	580lm	580lm	11,5VA	3h
201353-SC	PROTECT BEL-R DM EB-SC LED	6W LED-Leiste	580lm	580lm	11,5VA	3h
201353-SL	PROTECT BEL-R DM EB-SL LED	6W LED-Leiste	580lm	580lm	11,5VA	3h
201353-SWX	PROTECT BEL-R DM EB-SWX LED	6W LED-Leiste	580lm	580lm	12VA	3h
201358	PROTECT BEL-R DM EB LED	6W LED-Leiste	580lm	320lm	11,5VA	8h
201358-SC	PROTECT BEL-R DM EB-SC LED	6W LED-Leiste	580lm	320lm	11,5VA	8h
201358-SL	PROTECT BEL-R DM EB-SL LED	6W LED-Leiste	580lm	320lm	11,5VA	8h
201358-SWX	PROTECT BEL-R DM EB-SWX LED	6W LED-Leiste	580lm	320lm	12VA	8h



PROTECT BEL-R Deckenmontage



Bestell-Nr.	Bezeichnung	Leuchtmittel	Lichtstrom Netzbetrieb	Lichtstrom Notbetrieb	Netzanschluss- leistung	Nennbe- triebsdauer
mit Akkuheizung Temperaturbereich BS -20°C bis +35°C / DS -20°C bis +30°C						
201345	PROTECT BEL-R DM EB LED + AkH	3W LED-Leiste	350lm	350lm	6VA	3h
201345-SC	PROTECT BEL-R DM EB-SC LED + AKH	3W LED-Leiste	350lm	350lm	6VA	3h
201345-SL	PROTECT BEL-R DM EB-SL LED + AkH	3W LED-Leiste	350lm	350lm	6VA	3h
201345-SWX	PROTECT BEL-R DM EB-SWX LED + AkH	3W LED-Leiste	350lm	350lm	6,5VA	3h
201354	PROTECT BEL-R DM EB LED + AkH	6W LED-Leiste	580lm	580lm	11,5VA	3h
201354-SC	PROTECT BEL-R DM EB-SC LED + AKH	6W LED-Leiste	580lm	580lm	11,5VA	3h
201354-SL	PROTECT BEL-R DM EB-SL LED + AkH	6W LED-Leiste	580lm	580lm	11,5VA	3h
201354-SWX	PROTECT BEL-R DM EB-SWX LED + AkH	6W LED-Leiste	580lm	580lm	12VA	3h
201359	PROTECT BEL-R DM EB LED + AkH	6W LED-Leiste	580lm	320lm	11,5VA	8h
201359-SC	PROTECT BEL-R DM EB-SC LED + AKH	6W LED-Leiste	580lm	320lm	11,5VA	8h
201359-SL	PROTECT BEL-R DM EB-SL LED + AkH	6W LED-Leiste	580lm	320lm	11,5VA	8h
201359-SWX	PROTECT BEL-R DM EB-SWX LED + AkH	6W LED-Leiste	580lm	320lm	12VA	8h

Bestell-Nr.	Bezeichnung	Leuchtmittel	Lichtstrom Netzbetrieb	Lichtstrom Notbetrieb	Netzanschluss- leistung	Nennbe- triebsdauer
mit externer Versorgung Temperaturbereich BS -35°C bis +35°C / DS -35°C bis +30°C						
201341	PROTECT BEL-R DM EB LED + ExV	3W LED-Leiste	350lm	350lm	6VA	1h
201341-SC	PROTECT BEL-R DM EB-SC LED + ExV	3W LED-Leiste	350lm	350lm	6VA	1h
201341-SL	PROTECT BEL-R DM EB-SL LED + ExV	3W LED-Leiste	350lm	350lm	6VA	1h
201341-SWX	PROTECT BEL-R DM EB-SWX LED + ExV	3W LED-Leiste	350lm	350lm	6,5VA	1h
201356	PROTECT BEL-R DM EB LED + ExV	6W LED-Leiste	580lm	580lm	11,5VA	1h
201356-SC	PROTECT BEL-R DM EB-SC LED + ExV	6W LED-Leiste	580lm	580lm	11,5VA	1h
201356-SL	PROTECT BEL-R DM EB-SL LED + ExV	6W LED-Leiste	580lm	580lm	11,5VA	1h
201356-SWX	PROTECT BEL-R DM EB-SWX LED + ExV	6W LED-Leiste	580lm	580lm	12VA	1h
201340	PROTECT BEL-R DM EB LED + ExV	3W LED-Leiste	350lm	350lm	6VA	3h
201340-SC	PROTECT BEL-R DM EB-SC LED + ExV	3W LED-Leiste	350lm	350lm	6VA	3h
201340-SL	PROTECT BEL-R DM EB-SL LED + ExV	3W LED-Leiste	350lm	350lm	6VA	3h
201340-SWX	PROTECT BEL-R DM EB-SWX LED + ExV	3W LED-Leiste	350lm	350lm	6,5VA	3h
201357	PROTECT BEL-R DM EB LED + ExV	6W LED-Leiste	580lm	580lm	11,5VA	3h
201357-SC	PROTECT BEL-R DM EB-SC LED + ExV	6W LED-Leiste	580lm	580lm	11,5VA	3h
201357-SL	PROTECT BEL-R DM EB-SL LED + ExV	6W LED-Leiste	580lm	580lm	11,5VA	3h
201357-SWX	PROTECT BEL-R DM EB-SWX LED + ExV	6W LED-Leiste	580lm	580lm	12VA	3h
201360	PROTECT BEL-R DM EB LED + ExV	6W LED-Leiste	580lm	320lm	11,5VA	8h
201360-SC	PROTECT BEL-R DM EB-SC LED + ExV	6W LED-Leiste	580lm	320lm	11,5VA	8h
201360-SL	PROTECT BEL-R DM EB-SL LED + ExV	6W LED-Leiste	580lm	320lm	11,5VA	8h
201360-SWX	PROTECT BEL-R DM EB-SWX LED + ExV	6W LED-Leiste	580lm	320lm	12VA	8h

Zubehör Systemleuchten und Einzelbatterieleuchten

Bestell-Nr.	Bezeichnung	Anmerkung	siehe Zubehör
550237	Druckausgleichsventil Zubehör-Set		S. 350
551038	Zentralpendel 300 mm (mit Vorverdrahtung)		S. 343
551039	Zentralpendel 500 mm (mit Vorverdrahtung)		S. 343
551040	Zentralpendel 1000 mm (mit Vorverdrahtung)		S. 343
551042	Seilmontageset, 2 x 2,5 Meter		S. 344
551043	Seilmontageset, 2 x 7,5 Meter		S. 344
551284	Mast- und Wandhalterung IMPACT & PROTECT, schwenkbar		S. 347
551285	Universalabdeckplatte für Deckenausschnitte		S. 343



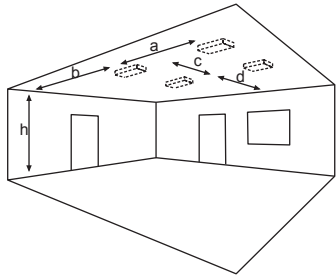
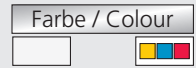

Lichtverteilungskurven und Leuchtenabstandstabellen (E = 1,25 lx)

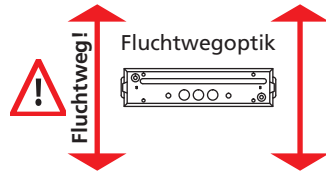

Systemleuchten für Zentralversorgung

Abstandstabelle ebene Fluchtwege / Tabellenangaben in Meter

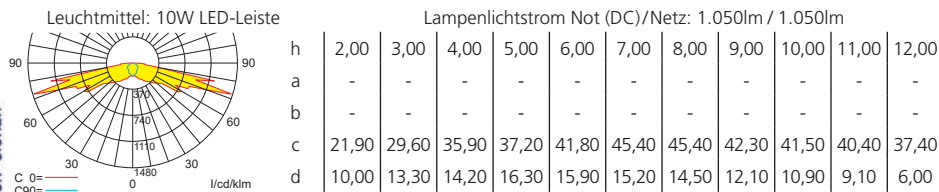
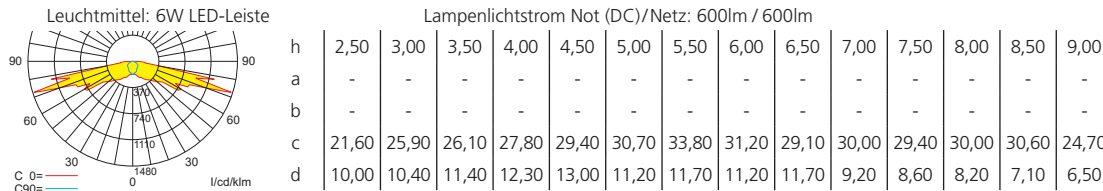
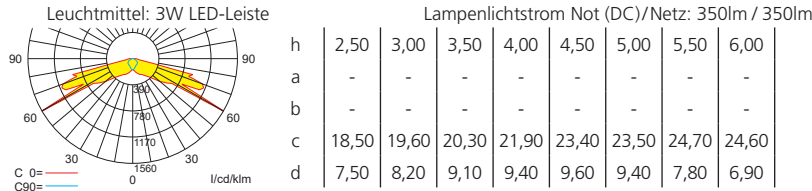

Einzelbatterieleuchten

Abstandstabelle ebene Fluchtwege / Tabellenangaben in Meter

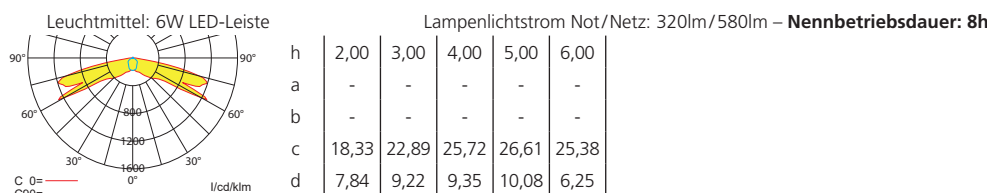
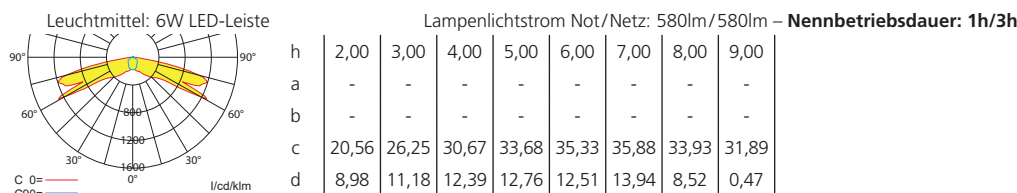
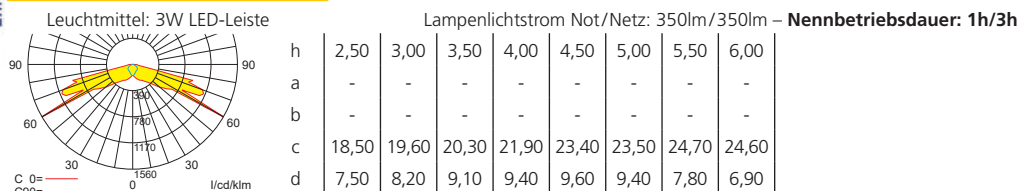

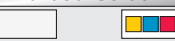

PROTECT BEL-T Deckenmontage



- Sicherheitsleuchte als Hallentiefstrahler mit Tiefstrahlloptiken.
- Die Leuchte entspricht dem IFS (International Food Standard) und ist auf die Schlagfestigkeit IK08 geprüft.
- Die Varianten mit 6W und 10W können in Bereichen mit besonderer Gefährdung (Min. 15lx) eingesetzt werden.
- Die Leuchte ist ballwurfsicher DIN 18032-3.
- Die 10W-Variante verfügt über einen Aluminium-Kühlkörper.
- Für die ungeschützte Außenmontage kann die Leuchte optional mit einem Druckausgleichsventil ausgestattet werden, welches vor Ort einzubauen ist.
- Gegen Aufpreis ist die Leuchte in der 3W und 6W-Variante für Zentralbatterie-Nennspannungen von **24V** und **110V** und in der 10W-Variante für **24V** erhältlich.
- Anschlussklemmen: 2 x 2,5 mm² für Doppelbelegung
- Gehäuse: Polycarbonat (Leuchtenhaube klar)
- Farbe: weiß
- Abmessungen (B x H x T): 370 x 140 x 93 mm
- Schutzart: IP65
- Schutzklasse: II

■ Systemleuchten für Zentralversorgung

Technische Daten

Anschlussspannung 230V 50/60Hz, 220V DC +25/-20%

Temperaturbereich -10°C bis +40°C

Bestelldaten

Bestell-Nr.	Bezeichnung	Leuchtmittel	Lichtstrom	Netzanschlussleistung	Batteriestromaufnahme
101380	PROTECT BEL-T DM LED	3W LED-Leiste	350lm	6VA	19mA
101380-DA	PROTECT BEL-T DM LED + DALI	3W LED-Leiste	350lm	6VA	19mA
101380-ELC	PROTECT BEL-T DM LED + ELC	3W LED-Leiste	350lm	6,5VA	19mA
101380-MSÜ	PROTECT BEL-T DM LED + MSÜ3	3W LED-Leiste	350lm	6,5VA	19mA
101380-SE	PROTECT BEL-T DM LED + SET009	3W LED-Leiste	350lm	6,5VA	19mA
101380-ST	PROTECT BEL-T DM LED + SET010	3W LED-Leiste	350lm	6,5VA	19mA
101370	PROTECT BEL-T DM LED	6W LED-Leiste	600lm	10,3VA	27mA
101370-ELC	PROTECT BEL-T DM LED + ELC	6W LED-Leiste	600lm	10,8VA	27mA
101370-MSÜ	PROTECT BEL-T DM LED + MSÜ3	6W LED-Leiste	600lm	10,8VA	27mA
101370-SE	PROTECT BEL-T DM LED + SET009	6W LED-Leiste	600lm	10,8VA	27mA
101370-ST	PROTECT BEL-T DM LED + SET010	6W LED-Leiste	600lm	10,8VA	27mA
101375	PROTECT BEL-T DM LED	10W LED-Leiste	1.050lm	15VA	41mA
101375-ELC	PROTECT BEL-T DM LED + ELC	10W LED-Leiste	1.050lm	15,5VA	41mA
101375-MSÜ	PROTECT BEL-T DM LED + MSÜ3	10W LED-Leiste	1.050lm	15,5VA	41mA
101375-SE	PROTECT BEL-T DM LED + SET009	10W LED-Leiste	1.050lm	15,5VA	41mA
101375-ST	PROTECT BEL-T DM LED + SET010	10W LED-Leiste	1.050lm	15,5VA	41mA

■ Einzelbatterieeleuchten

Technische Daten

Anschlussspannung 230V 50/60Hz

Temperaturbereich BS 0°C bis +35°C

NiMh-Akku 4,8V 2,0Ah (Best.-Nr. 570008) (1h) / 4,8V 4,2Ah (Best.-Nr. 570006) (3h) = 3W LED-Leiste
4,8V 2,0Ah (Best.-Nr. 570008) (1h) / 4,8V 4,2Ah (Best.-Nr. 570006) (1h+3h) = 6W LED-Leiste

Temperaturbereich DS -5°C bis +30°C

Lichtstromverhältnis 100% / 100 % Not/Netz (1h+3h) = 3W + 6W LED-Leiste
55% / 100 % Not/Netz (8h) = 6W _ED-Leiste

Bestelldaten

Bestell-Nr.	Bezeichnung	Leuchtmittel	Lichtstrom Netzbetrieb	Lichtstrom Notbetrieb	Netzanschlussleistung	Nennbetriebsdauer
201381	PROTECT BEL-T DM EB LED	3W LED-Leiste	350lm	350lm	6VA	1h
201381-SC	PROTECT BEL-T DM EB-SC LED	3W LED-Leiste	350lm	350lm	6VA	1h
201381-SL	PROTECT BEL-T DM EB-SL LED	3W LED-Leiste	350lm	350lm	6VA	1h
201381-SWX	PROTECT BEL-T DM EB-SWX LED	3W LED-Leiste	350lm	350lm	6,5VA	1h
201382	PROTECT BEL-T DM EB LED	6W LED-Leiste	580lm	580lm	11,5VA	1h
201382-SC	PROTECT BEL-T DM EB-SC LED	6W LED-Leiste	580lm	580lm	11,5VA	1h
201382-SL	PROTECT BEL-T DM EB-SL LED	6W LED-Leiste	580lm	580lm	11,5VA	1h
201382-SWX	PROTECT BEL-T DM EB-SWX LED	6W LED-Leiste	580lm	580lm	12VA	1h
201380	PROTECT BEL-T DM EB LED	3W LED-Leiste	350lm	350lm	6VA	3h
201380-SC	PROTECT BEL-T DM EB-SC LED	3W LED-Leiste	350lm	350lm	6VA	3h
201380-SL	PROTECT BEL-T DM EB-SL LED	3W LED-Leiste	350lm	350lm	6VA	3h
201380-SWX	PROTECT BEL-T DM EB-SWX LED	3W LED-Leiste	350lm	350lm	6,5VA	3h
201383	PROTECT BEL-T DM EB LED	6W LED-Leiste	580lm	580lm	11,5VA	3h
201383-SC	PROTECT BEL-T DM EB-SC LED	6W LED-Leiste	580lm	580lm	11,5VA	3h
201383-SL	PROTECT BEL-T DM EB-SL LED	6W LED-Leiste	580lm	580lm	11,5VA	3h
201383-SWX	PROTECT BEL-T DM EB-SWX LED	6W LED-Leiste	580lm	580lm	12VA	3h
201384	PROTECT BEL-T DM EB LED	6W LED-Leiste	580lm	320lm	11,5VA	8h
201384-SC	PROTECT BEL-T DM EB-SC LED	6W LED-Leiste	580lm	320lm	11,5VA	8h
201384-SL	PROTECT BEL-T DM EB-SL LED	6W LED-Leiste	580lm	320lm	11,5VA	8h
201384-SWX	PROTECT BEL-T DM EB-SWX LED	6W LED-Leiste	580lm	320lm	12VA	8h





PROTECT BEL-T Deckenmontage

■ Zubehör Systemleuchten und Einzelbatterieleuchten

Bestell-Nr.	Bezeichnung	Anmerkung	siehe Zubehör
550237	Druckausgleichsventil Zubehör-Set		S. 350
551038	Zentralpendel 300 mm (mit Vorverdrahtung)		S. 343
551039	Zentralpendel 500 mm (mit Vorverdrahtung)		S. 343
551040	Zentralpendel 1000 mm (mit Vorverdrahtung)		S. 343
551042	Seilmontageset, 2 x 2,5 Meter		S. 344
551043	Seilmontageset, 2 x 7,5 Meter		S. 344
551284	Mast- und Wandhalterung IMPACT & PROTECT, schwenkbar		S. 347
551285	Universalabdeckplatte für Deckenausschnitte		S. 343

PROTECT BEL-T Deckenmontage

Lichtverteilungskurven und Leuchtenabstandstabellen (E = 1,25 lx)

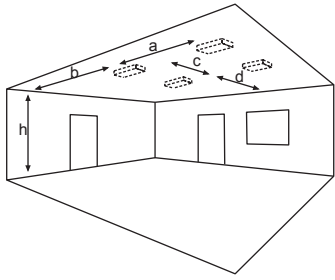

Systemleuchten für Zentralversorgung

Abstandstabelle ebene Fluchtwege / Tabellenangaben in Meter

Leuchtmittel: 3W LED-Leiste

Lampenlichtstrom Not (DC)/Netz: 350lm / 350lm

	h	7,00	8,00	9,00	10,00	11,00	12,00	13,00	14,00	15,00	16,00	17,00	18,00	19,00	20,00
	a	9,60	10,50	11,20	11,90	12,30	12,60	12,90	13,00	13,10	12,80	12,70	12,20	11,50	11,00
	b	4,10	4,40	4,50	4,60	4,60	4,50	4,20	3,90	3,60	3,20	2,80	2,20	1,80	0,90
	c	9,60	10,50	11,30	12,00	12,50	12,80	12,90	13,00	12,90	12,70	12,50	12,10	11,50	10,90
	d	4,20	4,50	4,50	4,60	4,50	4,40	4,20	3,90	3,40	3,10	3,00	2,60	2,20	1,60

Leuchtmittel: 6W LED-Leiste

Lampenlichtstrom Not (DC)/Netz: 600lm / 600lm

	h	7,00	8,00	9,00	10,00	11,00	12,00	13,00	14,00	15,00	16,00	17,00	18,00	19,00	20,00	21,00	22,00	23,00	24,00
	a	11,30	11,90	13,10	14,10	15,00	15,70	16,30	17,10	17,40	17,70	17,70	17,70	17,30	16,90	16,30	15,80	15,20	14,30
	b	4,90	5,40	5,70	6,00	6,40	6,30	6,20	6,00	5,70	5,50	5,00	4,70	4,30	4,00	3,90	3,60	2,70	2,40
	c	11,40	11,80	12,50	13,60	14,60	15,50	16,30	17,00	17,20	17,50	17,70	17,60	17,20	16,70	16,20	15,40	14,50	13,70
	d	4,70	5,20	5,70	6,00	6,40	6,30	6,20	5,90	5,60	5,20	4,80	4,40	3,90	3,80	3,70	3,40	3,00	2,60

Leuchtmittel: 10W LED-Leiste

Lampenlichtstrom Not (DC)/Netz: 1.050lm / 1.050lm

	h	7,00	9,00	11,00	13,00	15,00	17,00	19,00	21,00	23,00	25,00	27,00	29,00	31,00	33,00
	a	13,80	14,80	16,30	18,50	20,20	21,50	22,90	23,40	23,30	23,00	21,90	21,00	19,50	18,30
	b	5,30	6,40	7,30	7,90	8,50	8,20	7,70	7,30	6,50	5,80	5,30	4,80	3,40	2,20
	c	14,10	14,90	16,00	17,80	19,80	21,50	22,60	23,10	23,30	22,80	21,80	20,50	18,70	17,20
	d	5,40	6,20	7,10	7,90	8,50	8,20	7,70	7,00	6,20	5,30	5,00	4,50	3,70	2,90

Einzelbatterieleuchten

Abstandstabelle ebene Fluchtwege / Tabellenangaben in Meter

Leuchtmittel: 3W LED-Leiste

Lampenlichtstrom Not/Netz: 350lm/350lm – Nennbetriebsdauer: 1h/3h

	h	7,00	8,00	9,00	10,00	11,00	12,00	13,00	14,00	15,00	16,00	17,00	18,00	19,00	20,00
	a	9,60	10,50	11,20	11,90	12,30	12,60	12,90	13,00	13,10	12,80	12,70	12,20	11,50	11,00
	b	4,10	4,40	4,50	4,60	4,60	4,50	4,20	3,90	3,60	3,20	2,80	2,20	1,80	0,90
	c	9,60	10,50	11,30	12,00	12,50	12,80	12,90	13,00	12,90	12,70	12,50	12,10	11,50	10,90
	d	4,20	4,50	4,50	4,60	4,50	4,40	4,20	3,90	3,40	3,10	3,00	2,60	2,20	1,60

Leuchtmittel: 6W LED-Leiste

Lampenlichtstrom Not/Netz: 580lm/580lm – Nennbetriebsdauer: 1h/3h

	h	7,00	9,00	11,00	13,00	15,00	17,00	19,00	21,00	23,00	25,00	27,00	29,00	31,00
	a	11,03	12,25	13,28	14,13	14,82	15,34	15,68	15,97	16,08	16,03	15,89	15,53	15,09
	b	4,49	4,96	5,29	5,51	5,65	5,69	5,62	5,44	5,16	4,75	4,16	3,3	1,78
	c	11,03	12,25	13,28	14,13	14,82	15,34	15,68	15,97	16,08	16,03	15,89	15,53	15,09
	d	4,49	4,96	5,29	5,51	5,65	5,69	5,62	5,44	5,16	4,75	4,16	3,3	1,78

Leuchtmittel: 6W LED-Leiste

Lampenlichtstrom Not/Netz: 320lm/580lm – Nennbetriebsdauer: 8h

	h	7,00	9,00	11,00	13,00	15,00	17,00	19,00	21,00	23,00
	a	9,27	10,22	10,96	11,48	11,8	11,94	11,88	11,65	11,21
	b	3,74	4,03	4,19	4,21	4,1	3,84	3,41	2,73	1,35
	c	9,27	10,22	10,96	11,48	11,8	11,94	11,88	11,65	11,21
	d	3,74	4,03	4,19	4,21	4,1	3,84	3,41	2,73	1,35



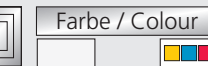

PROTECT BEL-T Deckenmontage

Lichtverteilungskurven und Leuchtenabstandstabellen (E = 18,75 lx)

Systemleuchten für Zentralversorgung

Abstandstabelle ebene Fluchtwege / Tabellenangaben in Meter

Leuchtmittel: 10W LED-Leiste

Lampenlichtstrom Not (DC)/Netz: 1.050lm / 1.050lm

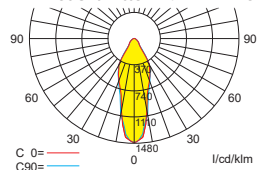

h	2,00	3,00	4,00	5,00	6,00	7,00	8,00	9,00
a	3,80	4,40	5,40	6,10	6,30	6,00	5,40	4,70
b	1,50	2,00	2,30	2,10	1,80	1,40	1,10	0,30
c	3,80	4,30	5,30	6,00	6,20	6,00	5,20	4,40
d	1,50	1,90	2,30	2,10	1,70	1,40	1,10	0,30

Einzelbatterieleuchten

Abstandstabelle ebene Fluchtwege / Tabellenangaben in Meter

Leuchtmittel: 6W LED-Leiste

Lampenlichtstrom Not/Netz: 580lm/580lm – Nennbetriebsdauer: 3h

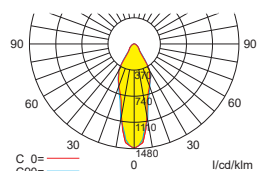

h	4,00	5,00	6,00	7,00	8,00
a	3,90	4,10	4,10	4,10	3,90
b	1,50	1,40	1,30	1,10	0,50
c	3,90	4,10	4,10	4,10	3,90
d	1,50	1,40	1,30	1,10	0,50

